



FALL 2021
WINTER



Civilization of Beauty





BRECCIA ARGENTUM

M A R M O e P I E T R A

WALL
BRECCIA ARGENTUM NATURALE 320x160_126"x63" MM 6

BAR COUNTER
BRECCIA ARGENTUM LAPPATO 324x163_127"x64" MM 20

FLOOR
BRECCIA ARGENTUM LAPPATO 320x160_126"x63" MM 6

324x163_127"x64"



20 MM



163912 Nat
163911 Lap

324x163_127"x64"



12 MM



163902 Nat
163901 Lap 163908B slab B Nat
163907B slab B Lap

320x160_126"x63"



6 MM



163002 Nat Ret
163001 Lap Ret

280x120_110"x48"



163012 Nat Ret
163011 Lap Ret

120x120_48"x48"



163021 Lap Ret

60x120_24"x48"



8,8 MM



163101 Lap Ret



BRECCIA ARGENTUM



FLOOR
BRECCIA ARGENTUM LAPPATO 320x160_126"x63" MM 6

MARMO E PIETRA

V2
SHADE SPECTRUM
MODERATE

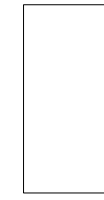

20 MM

324x163
127"x64"

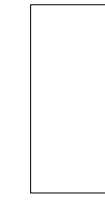

12 MM

324x163
127"x64"



6 MM

320x160
126"x63"

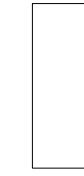

6 MM

280x120
110"x48"



6 MM

120x120
48"x48"



8,8 MM

60x120
24"x48"

	Nat	Lap	Nat	Lap	Nat Ret	Lap Ret	Nat Ret	Lap Ret	Lap Ret	Lap Ret
BRECCIA ARGENTUM	163912	163911	163902	163901	163002	163001	163012	163011	163021	163101
CODICE PREZZO PRICE CODE	M276	M299	M221	M247	M173	M197	M153	M175	M169	M125

	345x175	330x75	345x175	330x75	330x75	345x175	330x75	302x136	330x75	250x75	143x123	80x120
h. (cm) ↑ ↓	37	193,5	37	193,5	193,5	37	193,5	33,8	193,5	153,5	64,7	75
tare (kg)	140	135	150	229	259	140	210	108	210	158	-	-
n. of slabs	5	12	10	22	22	14	44	20	44	88	-	-
m ² x slab	5,28		5,28			5,12		3,36		1,44		-
Kg x slab	254,84		152,47			74,14		48,65		20,85		-
pcs x	-	-	-	-	-	-	-	-	-	-	2	2
m ² x	-	-	-	-	-	-	-	-	-	-	2,88	1,44
Kg x	-	-	-	-	-	-	-	-	-	-	41,70	29,82
x	-	-	-	-	-	-	-	-	-	-	24	32
m ² x	26,40	63,36	52,80	116,16	116,16	71,68	225,28	67,20	147,84	126,72	69,12	46,08
Kg x	1.414	3.193	1.674	3.583	3.613	1.178	3.472	1.081	2.350	1.993	1.057	974

Pallet speciale con sponde
Special pallet with sides

Epal

Cassa
Crate

Cavalletto in ferro
Iron A-Frame

Cavalletto in legno
Wood A-Frame



CALACATTA ORO

M A R M O e P I E T R A

WALL
CALACATTA ORO NATURALE SLAB A/B 324x163_127"x64" MM 12

BATHTUB
CALACATTA ORO LAPPATO 324x163_127"x64" MM 20

FLOOR
CALACATTA ORO LAPPATO 320x160_126"x63" MM 6

324x163_127"x64"



20 MM



163916 Nat
163915 Lap

BOOK MATCH

324x163_127"x64"

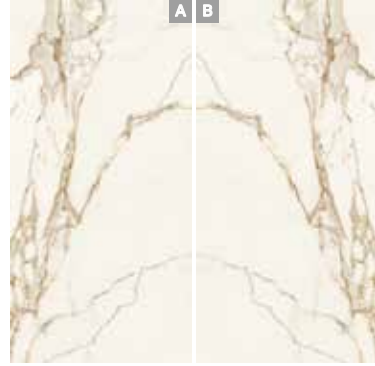

12 MM



163906 slab A Nat
163905 slab A Lap
163906B slab B Nat
163905B slab B Lap

320x160_126"x63"

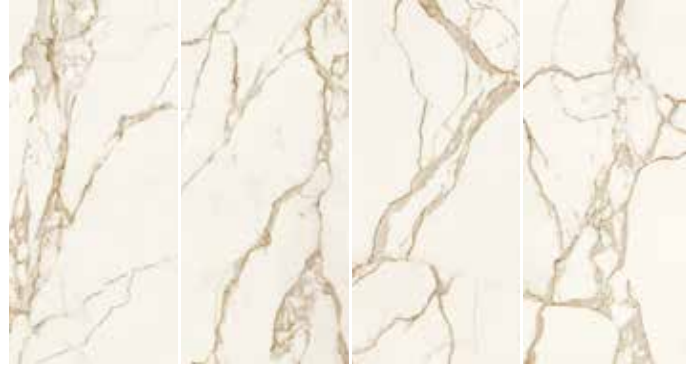

6 MM



163006 Nat Ret
163005 Lap Ret

280x120_110"x48"



163016 Nat Ret
163015 Lap Ret

120x120_48"x48"



163025 Lap Ret

GRES PORCELLANATO . PORCELAIN TILES

60x120_24"x48"

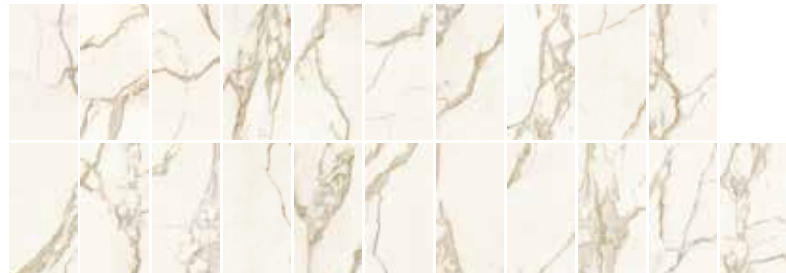

8,8 MM



163105 Lap Ret

V3
SHADE SPECTRUM
HIGH



CALACATTA
ORO



WALL
CALACATTA ORO NATURALE 324x163_127"x64" MM 12

MARMO E PIETRA

V3
SHADE SPECTRUM
HIGH

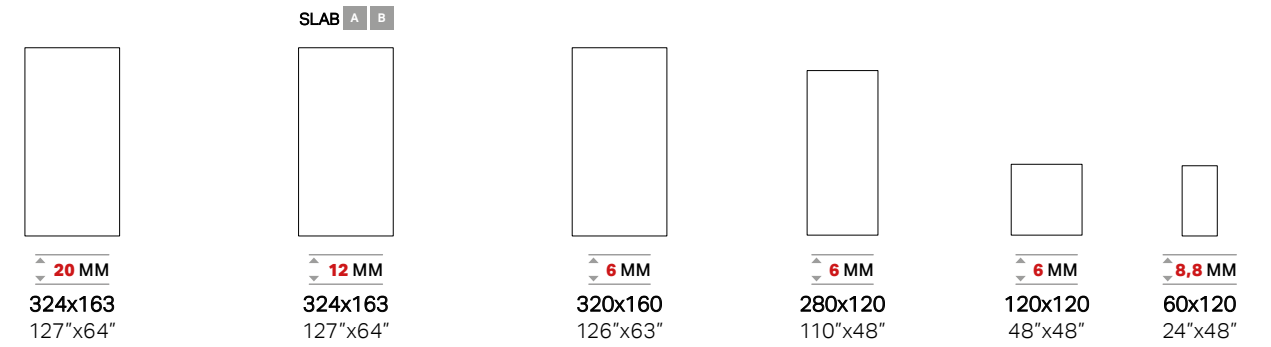

	20 MM		12 MM		6 MM		6 MM		6 MM		8.8 MM	
	Nat	Lap	Nat	Lap	Nat Ret	Lap Ret	Nat Ret	Lap Ret	Lap Ret	Lap Ret	Lap Ret	Lap Ret
CALACATTA ORO	163916	163915	A 163906 B 163906B	A 163905 B 163905B	163006	163005	163016	163015	163025	163105		
PREZZO PRICE	€218,00 M ²	€262,00 M ²	€154,00 M ²	€180,00 M ²	€106,00 M ²	€130,00 M ²	€86,00 M ²	€108,00 M ²	€102,00 M ²	€58,00 M ²		
CODICE PREZZO PRICE CODE	M276	M299	M221	M247	M173	M197	M153	M175	M169	M125		

	345x175	330x75	345x175	330x75	330x75	345x175	330x75	302x136	330x75	250x75	143x123	80x120
h. (cm)	37	193,5	37	193,5	193,5	37	193,5	33,8	193,5	153,5	64,7	75
tare (kg)	140	135	150	229	259	140	210	108	210	158	-	-
n. of slabs	5	12	10	22	22	14	44	20	44	88	-	-
m ² x slab		5,28		5,28		5,12		3,36		1,44	-	-
Kg x slab		254,84		152,47		74,14		48,65		20,85	-	-
pcs x		-	-	-	-	-	-	-	-	-	2	2
m ² x		-	-	-	-	-	-	-	-	-	2,88	1,44
Kg x		-	-	-	-	-	-	-	-	-	41,70	29,82
x		-	-	-	-	-	-	-	-	-	24	32
m ² x	26,40	63,36	52,80	116,16	116,16	71,68	225,28	67,20	147,84	126,72	69,12	46,08
Kg x	1,414	3,193	1,674	3,583	3,613	1,178	3,472	1,081	2,350	1,993	1,057	974

Pallet speciale con sponde
Special pallet with sides

Epal

Cassa
Crate

Cavalletto in ferro
Iron A-Frame

Cavalletto in legno
Wood A-Frame



MACCHIA ANTICA

M A R M O e P I E T R A

WALL
MACCHIA ANTICA LAPPATO 320x160_126"x63" MM 6

TABLE TOP
SKYLINE GHIACCIO 324x163_127"x64" MM 20

FLOOR
IL CERRETO AMARONE 23x149_9"x58½" MM 8,8

320x160_126"x63"



163004 Nat Ret
163003 Lap Ret

6 MM



280x120_110"x48"



163014 Nat Ret
163013 Lap Ret



120x120_48"x48"



163023 Lap Ret



60x120_24"x48"



163103 Lap Ret

8,8 MM



V3
SHADE SPECTRUM
HIGH



MACCHIA
ANTICA



COMPOSIZIONE DI NR 5 LASTRE A VENA CONTINUA FORMATO 320x160 SP 6 MM_126"x63" THK 6 MM DISPONIBILE CON FINITURA NATURALE RETTIFICATA OPPURE LAPPATA RETTIFICATA

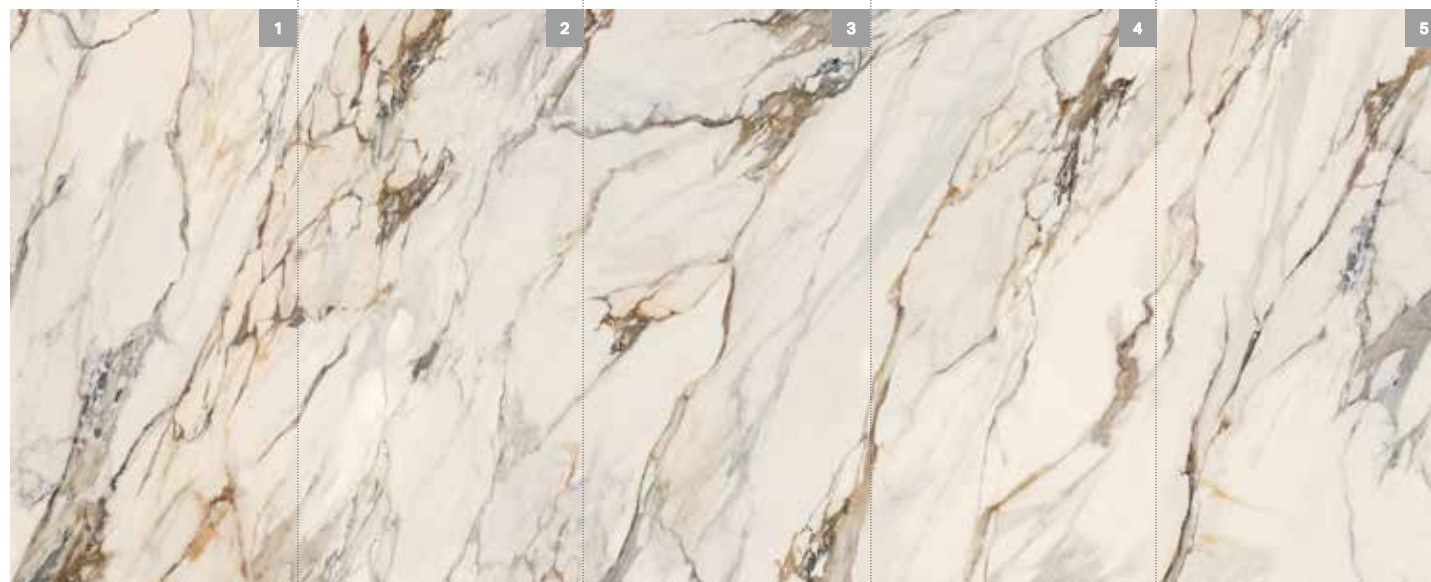

COMPOSITION WITH 5 CONTINUOUS VEIN TILES SIZE 320x160 THK 6 MM_126"x63" THK 6 MM AVAILABLE WITH NATURAL RECTIFIED OR LAPPED RECTIFIED FINISH.
COMPOSITION DE 5 PLAQUES À VEINES CONTINUES FORMAT 320x160 ÉP. 6 MM DISPONIBLE AVEC FINITION NATURELLE RECTIFIÉE OU RODÉE RECTIFIÉE.
ZUSAMMENSTELLUNG AUS 5 ST. PLATTEN MIT DURCHGEHENDER MARMORIERUNG, FORMAT 320x160, ST. 6 MM_126"x63" THK 6 MM VERFÜGBAR MIT FINISH NATUR GESCHLIFFEN ODER GELÄPPT GESCHLIFFEN.

COMPOSIZIONE DI NR 5 LASTRE A VENA CONTINUA FORMATO 280x120 SP 6 MM_110"x48" THK 6 MM DISPONIBILE CON FINITURA NATURALE RETTIFICATA OPPURE LAPPATA RETTIFICATA

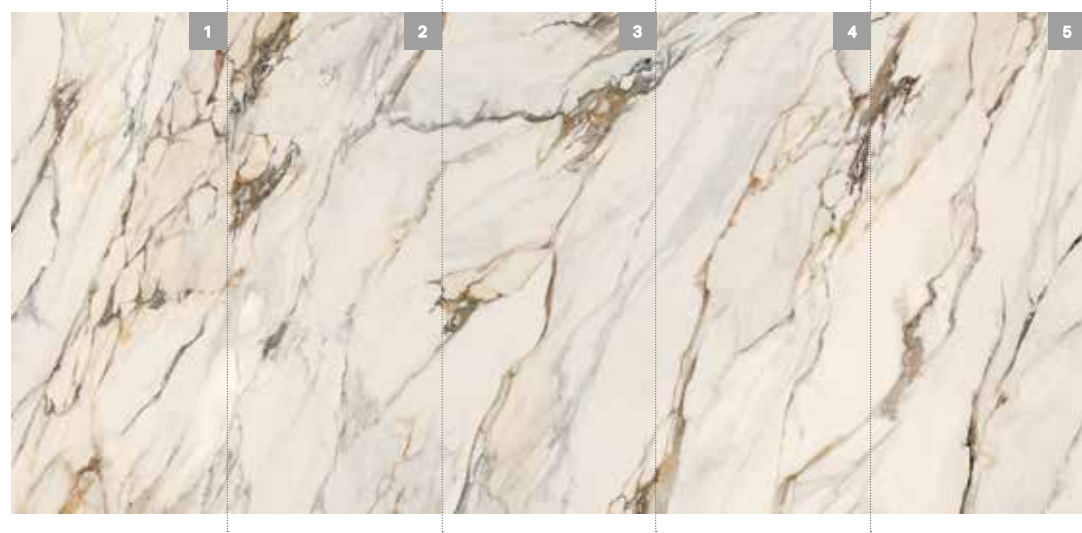

COMPOSITION WITH 5 CONTINUOUS VEIN TILES SIZE 280x120 SP 6 MM_110"x48" THK 6 MM AVAILABLE WITH NATURAL RECTIFIED OR LAPPED RECTIFIED FINISH.
COMPOSITION DE 5 PLAQUES À VEINES CONTINUES FORMAT 280x120 ÉP. 6 MM DISPONIBLE AVEC FINITION NATURELLE RECTIFIÉE OU RODÉE RECTIFIÉE.

ZUSAMMENSTELLUNG AUS 5 ST. PLATTEN MIT DURCHGEHENDER MARMORIERUNG, FORMAT 280x120, ST. 6 MM_110"x48" THK 6 MM VERFÜGBAR MIT FINISH NATUR GESCHLIFFEN ODER GELÄPPT GESCHLIFFEN.

LE LESTRE SONO FORNITE CON LE GRAFICHE **RANDOM**. POSSONO ESSERE FORNITE CON **COMPOSIZIONE A VENA CONTINUA** CON UNA MAGGIORAZIONE NEL PREZZO E SOLO SU RICHIESTA ESPLICITA DEL CLIENTE.

THE TILES ARE SUPPLIED WITH **RANDOM** GRAPHICS. THEY MAY BE SUPPLIED WITH **CONTINUOUS VEIN EFFECT** AT AN ADDITIONAL CHARGE AND ONLY IF SPECIFICALLY REQUESTED BY THE CUSTOMER.

LES PLAQUES SONT FOURNIES AVEC GRAPHIQUES ALÉATOIRES. ELLES SONT DISPONIBLES DANS LA COMPOSITION À NERVURES CONTINUES AVEC UNE MAJORATION SUR LE PRIX ET SEULEMENT SUR DEMANDE EXPLICITE DU CLIENT.

ODIE PLATTEN WERDEN MIT ZUFÄLLIGER MARMORIERUNG GELIEFERT. SIE KÖNNEN AUF AUSDRÜCKLICHEN WUNSCH DES KUNDEN GEGEN AUFPREIS AUCH MIT EINER DURCHGEHENDEN MARMORIERUNG GELIEFERT WERDEN.

IL DISEGNO RIPRODOTTO È INDICATIVO. **LA GRAFICA DI CHAIN** PUÒ MOSTRARE DISCONTINUITÀ DI VENA NEL PASSAGGIO DA UNA LASTRA ALL'ALTRA. PER QUESTO MOTIVO **DIFFERENZE FINO A 1,5 CM** DEVONO ESSERE CONSIDERATE COME CARATTERISTICA DEL PRODOTTO.

THE DRAWING IS PURELY ILLUSTRATIVE. THE GRAPHIC DESIGN OF **CHAIN** MAY RESULT IN DISCONTINUITIES IN THE VEINING BETWEEN PANELS. DISCONTINUITIES OF UP TO 1.5 CM ARE NOT DEFECTS, BUT ARE CHARACTERISTIC OF THE PRODUCT.

LE DESSIN REPRODUIT EST INDICATIF. DE MÊME QUE LE MATÉRIAU NATUREL, LE GRAPHISME DE CHAIN PEUT PRÉSENTER DES MARBRURES DISCONTINUES D'UNE DALLE À L'AUTRE. POUR CETTE RAISON, LES DIFFÉRENCES JUSQU'À 1,5 CM DOIVENT ÊTRE CONSIDÉRÉES COMME UNE CARACTÉRISTIQUE DU PRODUIT.

DIE WIEDERGEWEBENE ZEICHNUNG IST EINE MUSTERZEICHNUNG. WIE FÜR DAS NATÜRLICHE MATERIAL KANN AUCH DIE GRAFIK VON CHAIN BRÜCHE DER ADERUNGEN BEIM ÜBERGANG VON EINER PLATTE ZUR ANDERN AUFWEISEN. AUS DIESEM GRUND SIND UNTERSCHIEDE BIS ZU 1,5 CM ALS CHARAKTERISTIK DES PRODUKTS ZU BETRACHTEN.

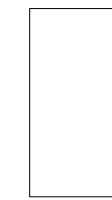

6 MM
320x160
126"x63"



6 MM
280x120
110"x48"



6 MM
120x120
48"x48"



8,8 MM
60x120
24"x48"

	Nat Ret	Lap Ret	Nat Ret	Lap Ret	Lap Ret	Lap Ret
MACCHIA ANTICA	163004	163003	163014	163013	163023	163103
CODICE PREZZO PRICE CODE	M173	M197	M153	M175	M169	M125

	345x175	330x75	302x136	330x75	250x75	143x123	80x120
h. (cm) ↑	37	193,5	33,8	193,5	153,5	64,7	75
tare (kg)	140	210	108	210	158	-	-
n. of slabs	14	44	20	44	88	-	-
m ² x slab	5,12		3,36		1,44	-	-
Kg x slab	74,14		48,65		20,85	-	-
pcs x	-	-	-	-	-	2	2
m ² x	-	-	-	-	-	2,88	1,44
Kg x	-	-	-	-	-	41,70	29,82
x	-	-	-	-	-	24	32
m ² x	71,68	225,28	67,20	147,84	126,72	69,12	46,08
Kg x	1.178	3.472	1.081	2.350	1.993	1.057	974

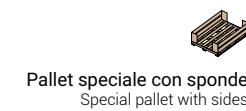

WALL
MACCHIA ANTICA LAPPATO 320x160_126"x63" MM 6

TABLE TOP
SKYLINE GHIACCIO 324x163_127"x64" MM 20

FLOOR
IL CERRETO AMARONE 23x149_9"x58½" MM 8,8



STATUARIO REALE

M A R M O e P I E T R A

WALL
STATUARIO REALE LAPPATO 320x160_126"x63" MM 6

TABLE TOP
STATUARIO REALE LAPPATO 324x163_127"x64" MM 20

FLOOR
STATUARIO REALE LAPPATO 320x160_126"x63" MM 6

324x163_127"x64"



20 MM



163918 Nat
163917 Lap

324x163_127"x64"

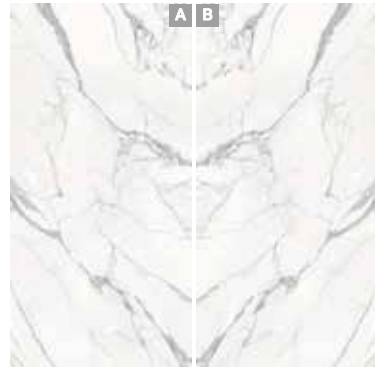

12 MM



163908 slab A Nat 163908B slab B Nat
163907 slab A Lap 163907B slab B Lap

320x160_126"x63"



6 MM



163008 Nat Ret
163007 Lap Ret

280x120_110"x48"



163018 Nat Ret
163017 Lap Ret

120x120_48"x48"

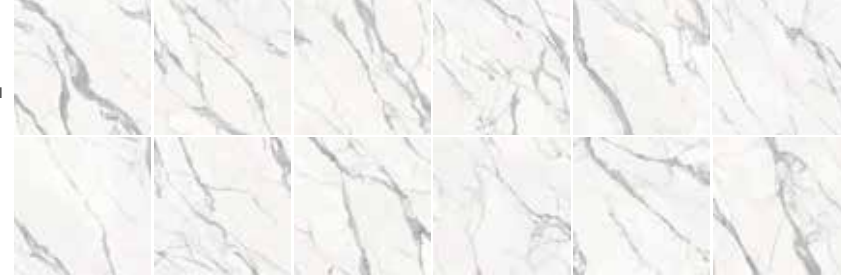

163027 Lap Ret

60x120_24"x48"

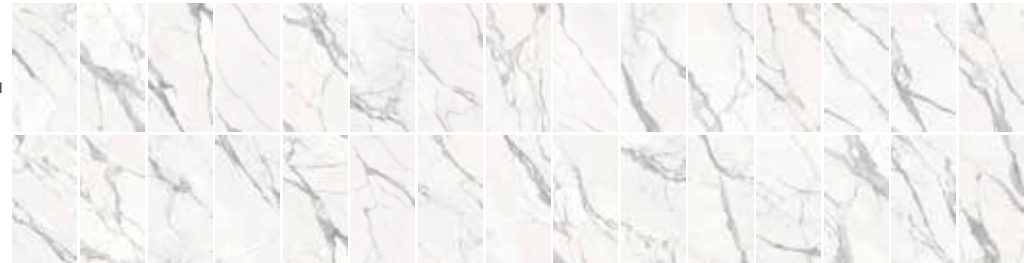

8,8 MM



163107 Lap Ret

STATUARIO REALE

COMPOSIZIONE DI NR 6 LASTRE A VENA CONTINUA FORMATO 320x160 SP 6 MM_126"x63" THK 6 MM
DISPONIBILE CON FINITURA NATURALE RETTIFICATA OPPURE LAPPATA RETTIFICATA



COMPOSITION WITH 6 CONTINUOUS VEIN TILES SIZE 320x160 THK 6 MM_126"x63" THK 6 MM AVAILABLE WITH NATURAL RECTIFIED OR LAPPED RECTIFIED FINISH.
COMPOSITION DE 6 PLAQUES À VEINES CONTINUES FORMAT 320x160 ÉP. 6 MM DISPONIBLE AVEC FINITION NATURELLE RECTIFIÉE OU RODÉE RECTIFIÉE.
ZUSAMMENSTELLUNG AUS 6 ST. PLATTEN MIT DURCHGEHENDER MARMORIERUNG, FORMAT 320x160, ST. 6 MM_126"x63" THK 6 MM VERFÜGBAR MIT FINISH NATUR GESCHLIFFEN ODER GELÄPPT GESCHLIFFEN.

COMPOSIZIONE DI NR 6 LASTRE A VENA CONTINUA FORMATO 280x120 SP 6 MM_110"x48" THK 6 MM
DISPONIBILE CON FINITURA NATURALE RETTIFICATA OPPURE LAPPATA RETTIFICATA



COMPOSITION WITH 6 CONTINUOUS VEIN TILES SIZE 280x120 SP 6 MM_110"x48" THK 6 MM AVAILABLE WITH NATURAL RECTIFIED OR LAPPED RECTIFIED FINISH.
COMPOSITION DE 6 PLAQUES À VEINES CONTINUES FORMAT 280x120 ÉP. 6 MM DISPONIBLE AVEC FINITION NATURELLE RECTIFIÉE OU RODÉE RECTIFIÉE.
ZUSAMMENSTELLUNG AUS 6 ST. PLATTEN MIT DURCHGEHENDER MARMORIERUNG, FORMAT 280x120, ST. 6 MM_110"x48" THK 6 MM VERFÜGBAR MIT FINISH NATUR GESCHLIFFEN ODER GELÄPPT GESCHLIFFEN.

LE LASTRE SONO FORNITE CON LE GRAFICHE **RANDOM**. POSSONO ESSERE FORNITE CON **COMPOSIZIONE A VENA CONTINUA** CON UNA MAGGIORAZIONE NEL PREZZO E SOLO SU RICHIESTA ESPLICITA DEL CLIENTE.

THE TILES ARE SUPPLIED WITH **RANDOM** GRAPHICS. THEY MAY BE SUPPLIED WITH **CONTINUOUS VEIN EFFECT** AT AN ADDITIONAL CHARGE AND ONLY IF SPECIFICALLY REQUESTED BY THE CUSTOMER.

LES PLAQUES SONT FOURNIES AVEC GRAPHIQUES ALÉATOIRES. ELLES SONT DISPONIBLES DANS LA COMPOSITION À NERVURES CONTINUES AVEC UNE MAJORATION SUR LE PRIX ET SEULEMENT SUR DEMANDE EXPLICITE DU CLIENT.

ODIE PLATTEN WERDEN MIT ZUFÄLLIGER MARMORIERUNG GELIEFERT. SIE KÖNNEN AUF AUSDRÜCKLICHEN WUNSCH DES KUNDEN GEGEN AUFPREIS AUCH MIT EINER DURCHGEHENDEN MARMORIERUNG GELIEFERT WERDEN.

IL DISEGNO RIPRODOTTO È INDICATIVO. **LA GRAFICA DI CHAIN** PUÒ MOSTRARE DISCONTINUITÀ DI VENA NEL PASSAGGIO DA UNA LASTRA ALL'ALTRA. PER QUESTO MOTIVO **DIFFERENZE FINO A 1,5 CM** DEVONO ESSERE CONSIDERATE COME CARATTERISTICA DEL PRODOTTO.

THE DRAWING IS PURELY ILLUSTRATIVE. THE GRAPHIC DESIGN OF **CHAIN** MAY RESULT IN DISCONTINUITIES IN THE VEINING BETWEEN PANELS. DISCONTINUITIES OF UP TO 1.5 CM ARE NOT DEFECTS, BUT ARE CHARACTERISTIC OF THE PRODUCT.

LE DESSIN REPRODUIT EST INDICATIF. DE MÊME QUE LE MATÉRIAU NATUREL, LE GRAPHISME DE **CHAIN** PEUT PRÉSENTER DES MARBRURES DISCONTINUES D'UNE DALLE À L'AUTRE. POUR CETTE RAISON, LES DIFFÉRENCES JUSQU'À 1,5 CM DOIVENT ÊTRE CONSIDÉRÉES COMME UNE CARACTÉRISTIQUE DU PRODUIT.

DIE WIEDERGEWEBENE ZEICHNUNG IST EINE MUSTERZEICHNUNG. WIE FÜR DAS NATÜRLICHE MATERIAL KANN AUCH DIE GRAFIK VON **CHAIN** BRÜCHE DER ADERUNGEN BEIM ÜBERGANG VON EINER PLATTE ZUR ANDERN AUFWEISEN. AUS DIESEM GRUND SIND UNTERSCHIEDE BIS ZU 1,5 CM ALS CHARAKTERISTIK DES PRODUKTS ZU BETRACHTEN.

BOOK MATCH COMPOSTO DA NR 2 LASTRE FORMATO 324x163 SP 12 MM_127"x64" THK 12 MM
DISPONIBILE CON FINITURA **NATURALE** OPPURE **LAPPATA**

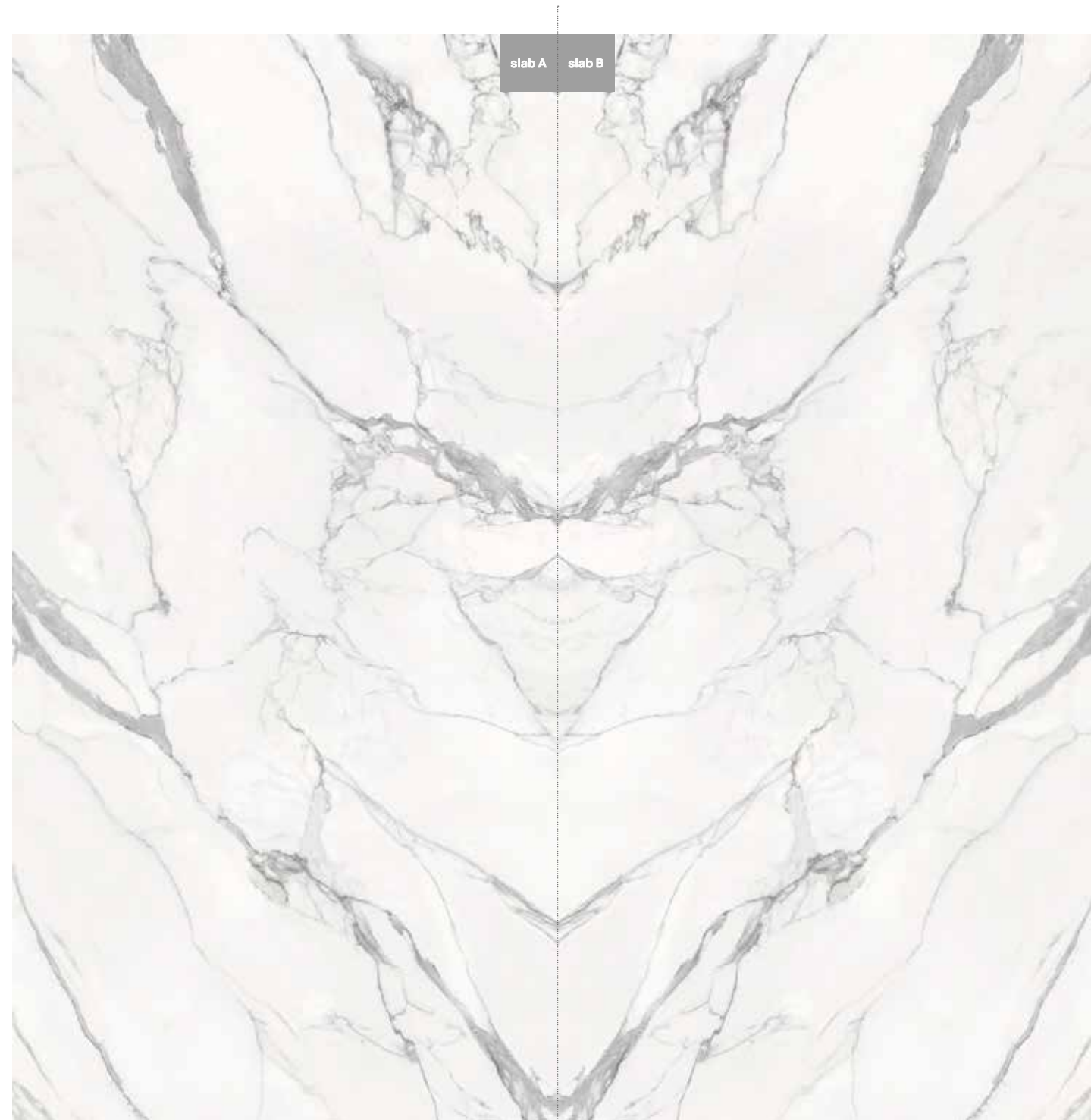

BOOK MATCH CONSISTING OF 2 TILES SIZE 324x163 THK 12 MM_127"x64" THK 12 MM AVAILABLE WITH NATURAL OR LAPPED FINISH.
BOOK MATCH COMPOSÉ DE 2 PLAQUES FORMAT 324x163 ÉP. 12 MM DISPONIBLE AVEC FINITION NATURELLE OU RODÉE.
BOOK MATCH BESTEHEND AUS 2 ST. PLATTEN FORMAT 324x163 ST. 12 MM_127"x64" THK 12 MM VERFÜGBAR MIT FINISH NATUR ODER GELÄPPT.



WALL
STATUARIO REALE LAPPATO 320x160_126"x63" MM 6

	20 MM		12 MM		6 MM		6 MM		6 MM		8,8 MM	
	324x163 127"x64"		324x163 127"x64"		320x160 126"x63"		280x120 110"x48"		120x120 48"x48"		60x120 24"x48"	
	Nat	Lap	Nat	Lap	Nat Ret	Lap Ret	Nat Ret	Lap Ret	Lap Ret	Lap Ret	Lap Ret	Lap Ret
STATUARIO REALE	163918	163917	A 163908 B 163908B	A 163907 B 163907B	163008	163007	163018	163017	163027	163107		
CODICE PREZZO PRICE CODE	M276	M299	M221	M247	M173	M197	M153	M175	M169	M125		

	345x175		330x75			345x175		330x75		302x136		330x75		250x75		143x123		80x120
h. (cm) ↓	37	193,5	37	193,5	193,5	37	193,5	33,8	193,5	153,5	64,7	75						
tare (kg)	140	135	150	229	259	140	210	108	210	158	-	-						
n. of slabs	5	12	10	22	22	14	44	20	44	88	-	-						
m ² x slab	5,28		5,28			5,12		3,36		1,44	-	-						
Kg x slab	254,84		152,47			74,14		48,65		20,85	-	-						
pcs x	-	-	-	-	-	-	-	-	-	-	2	2						
m ² x	-	-	-	-	-	-	-	-	-	-	2,88	1,44						
Kg x	-	-	-	-	-	-	-	-	-	-	41,70	29,82						
x	-	-	-	-	-	-	-	-	-	-	24	32						
m ² x	26,40	63,36	52,80	116,16	116,16	71,68	225,28	67,20	147,84	126,72	69,12	46,08						
Kg x	1.414	3.193	1.674	3.583	3.613	1.178	3.472	1.081	2.350	1.993	1.057	974						

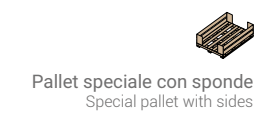

ARABESQUE
AZUL MACAUBA
BIANCO BERNINI



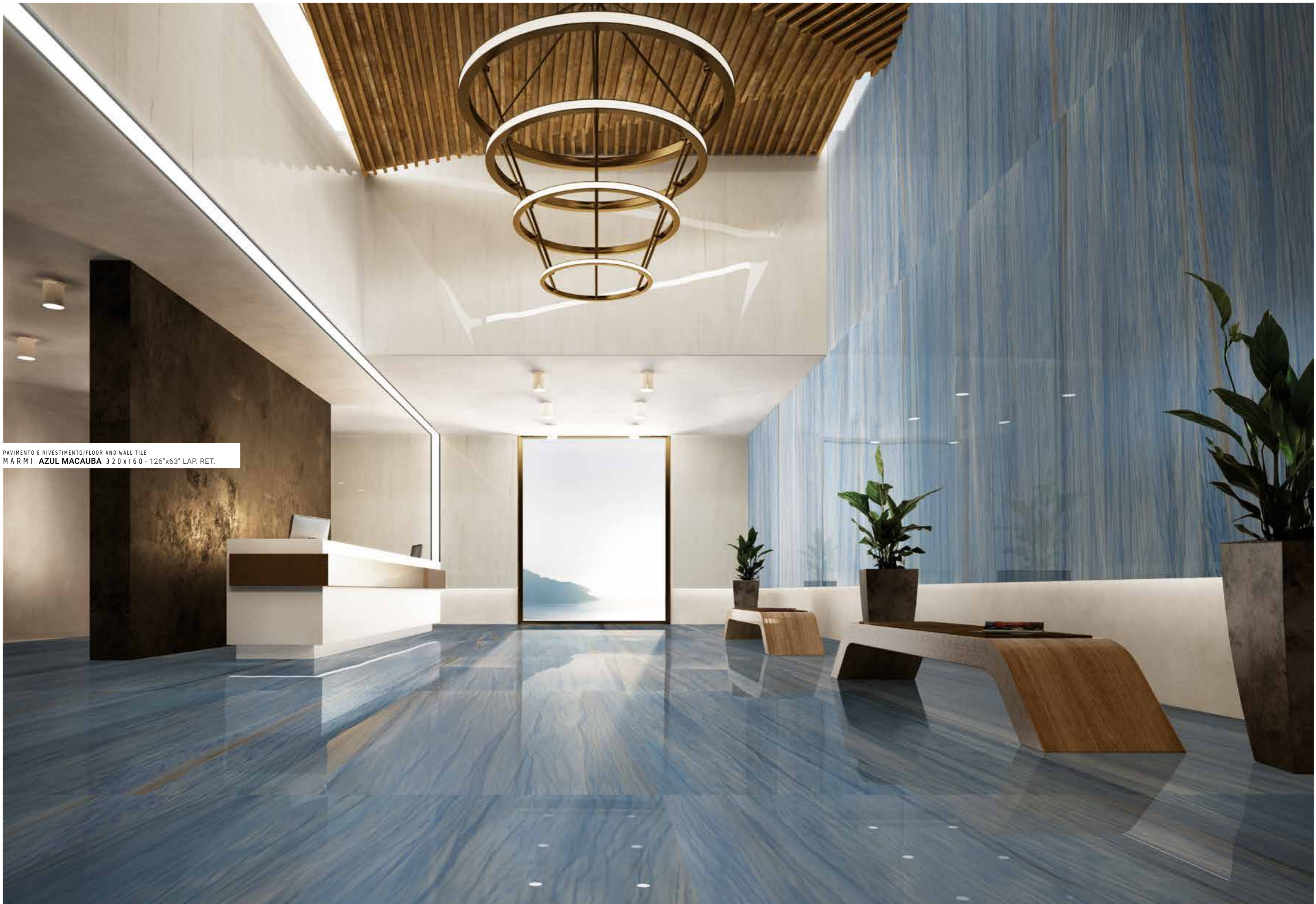

PAVIMENTO E RIVESTIMENTO/FLOOR AND WALL TILE
M A R M I | AZUL MACAUBA 320 x 160 - 126"x63" LAP. RET.

MARMI

ARABESQUE. AZUL MACAUBA. BIANCO BERNINI.

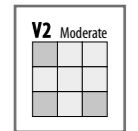

LASTRE IN GRES PORCELLANATO PRESSATE A SECCO

Dry-pressed porcelain stoneware slabs. Dalles en grès cérame pressées à sec. Trockengepresste Platten aus Feinsteinzeug. Planchas en gres porcelánico prensadas en seco. Керамогранитные плиты сухого прессования. 干压陶瓷砖

Spessore. Thickness. Epaisseur. Stärke. Espesor. Толщина. 厚度 6mm - 10mm - 12mm*

UNI EN 14411-ISO 13006 appendice G gruppo Bla - UGL

Grande varietà nelle grafiche per un pavimento o rivestimento sempre vario a effetto "naturale" - The collection is available in a wide variety of graphics for varied floor or wall solutions with a "natural" effect. Grande variété des graphiques pour un carrelage de sol ou un revêtement mural toujours différent et un effet "naturel". - Große Vielfalt der Graphiken für einen ständig unterschiedlichen Boden- oder Wandbelag mit "natürlicher" Effekt. - Gran variedad en las gráficas para un pavimento o revestimiento siempre diferente de efecto "natural". - Предлагается большое разнообразие рисунков для укладки всегда меняющегося пола или облицовки с натуральным эффектом. * 多样的图案让地板和涂层具有不同的“天然”色彩。

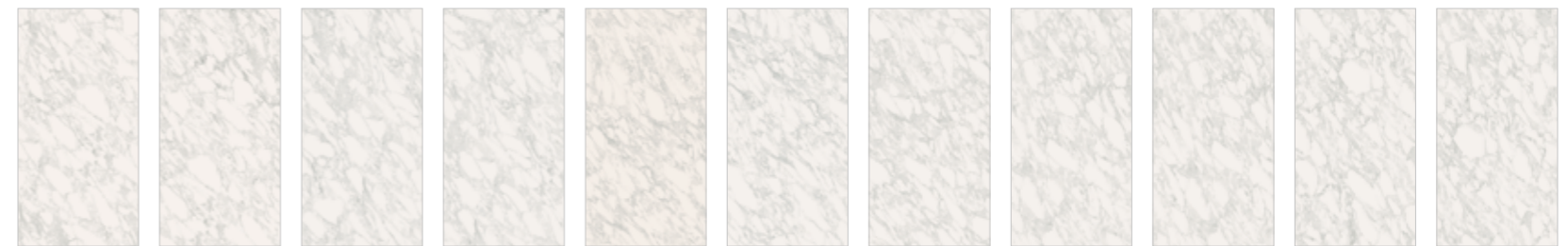

ARABESQUE

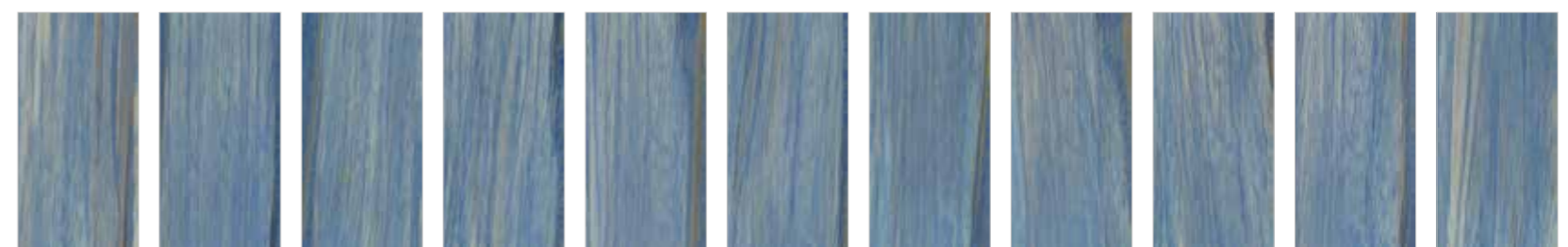

AZUL MACAUBA



BIANCO BERNINI

		320x160 126"x63" 6 mm	160x160 63"x63" 6 mm	280x120 110"x48" 6 mm	240x120 96"x48" 6 mm	120x120 48"x48" 6 mm	160x80 63"x31 1/2" 6 mm	240x80 96"x31 1/2" 6 mm	80x80 31 1/2"x31 1/2" 6 mm	100x100 40"x40" 10 mm	120x60 48"x24" 10 mm	60x60 24"x24" 10 mm	324x163 127"x64" 12 mm*
Arabesque	o Lap. Ret.	087015 M197	087051 M187	-	087035 M175	087071 M169	087091 M169	-	087111 M139	-	087130 M125	087150 M113	● Lap. Nat.
Azul Macauba	□ Nat. Ret.	087002 M173	087042 M161	-	087022 M153	087062 M141	087082 M141	-	087102 M125	-	087122♦ M109	087142♦ M089	■ Nat.
	o Lap. Ret.	087001 M197	087041 M187	-	087021 M175	087061 M169	087081 M169	-	087101 M139	-	087121 M125	087141 M113	● Lap. Nat.
Bianco Bernini	□ Nat. Ret.	083002 M173	083022 M161	-	083012 M153	083032 M141	083042 M141	-	083052 M125	-	083062♦ M109	083082♦ M089	■ Nat.
	o Lap. Ret.	083001 M197	083021 M187	-	083011 M175	083031 M169	083041 M169	-	083051 M139	-	083061 M125	083081♦ M113	● Lap. Nat.

Il formato 324x163 in 12 mm è prodotto senza stuoia. La stuoia potrà essere aggiunta solo su specifica richiesta. Lo spessore delle lastre stuoiate è di 12,7 mm. The 324x163 size 12 mm thickness is produced without the fiber glass mesh. The fiber glass mesh will be supplied only on demand. The thickness of the mesh-mounted is 12,7 mm.

- ★ **Disponibile con ordine minimo di 1.200 m².** Available with minimum order of 1,200 m². Quantité minimale par commande 1200 m². Erhältlich bei einer Mindestbestellmenge von 1.200 m². Disponible bajo pedido mínimo de 1.200 m². При минимальном заказе от 1200 м². 最少订购1,200平方米
- ♦ **Disponibile con ordine minimo di 2.000 m².** Available with minimum order of 2,000 m². Quantité minimale par commande 2000 m². Erhältlich bei einer Mindestbestellmenge von 2.000 m². Disponible bajo pedido mínimo de 2.000 m². При минимальном заказе от 2000 м². 最少订购2,000平方米

- **Lappato e rettificato.** Lappato and rectified. Lappato et rectifié. Lappato und kalibriert. Lappato y rectificado. Лаппатированный ректифицированный. 亚光和抛光。
- **Naturale e rettificato.** Natural and rectified. Naturel et rectifié. Natur Oberfläche und kalibriert. Natural y rectificado. Натуральный ректифицированный. 天然和抛光。
- **Lappato con bordi naturali.** Lappato with non rectified edges. Lappato à bords naturels. Lappato mit natürlichen Kanten. Pulido con los bordes natural. Лаппатированная поверхность с матовой кромкой. 抛光带天然磨边。
- **Naturale.** Natural. Naturel. Natur natur. Natural. Натуральный. 天然。

324x163
127"x64"
12 mm
1/2"

● Lap. Nat.



ARABESQUE

320x160
126"x63"
6 mm
1/4"

○ Lap. Ret.

324x163
127"x64"
12 mm
1/2"

● Lap. Nat.
■ Nat.



AZUL MACAUBA

320x160
126"x63"
6 mm
1/4"

□ Nat. Ret.
○ Lap. Ret.

324x163
127"x64"
12 mm
1/2"

● Lap. Nat.
■ Nat.



BIANCO BERNINI

320x160
126"x63"
6 mm
1/4"

□ Nat. Ret.
○ Lap. Ret.

★
Disponibile con ordine minimo di 1.200 m²

Available with minimum order of 1,200 m².
Quantité minimale par commande 1200 m².
Erhältlich bei einer Mindestbestellmenge von 1.200 m².
Disponible bajo pedido mínimo de 1.200 m².
При минимальном заказе от 1200 м².
最少订购1,200平方米

**BARDIGLIO CENERE
BRONZE AMANI**





PAVIMENTO E RIVESTIMENTO/FLOOR AND WALL TILE
M A R M I BARDIGLIO CENERE 320 x 160 - 126"x63" LAP. RET.

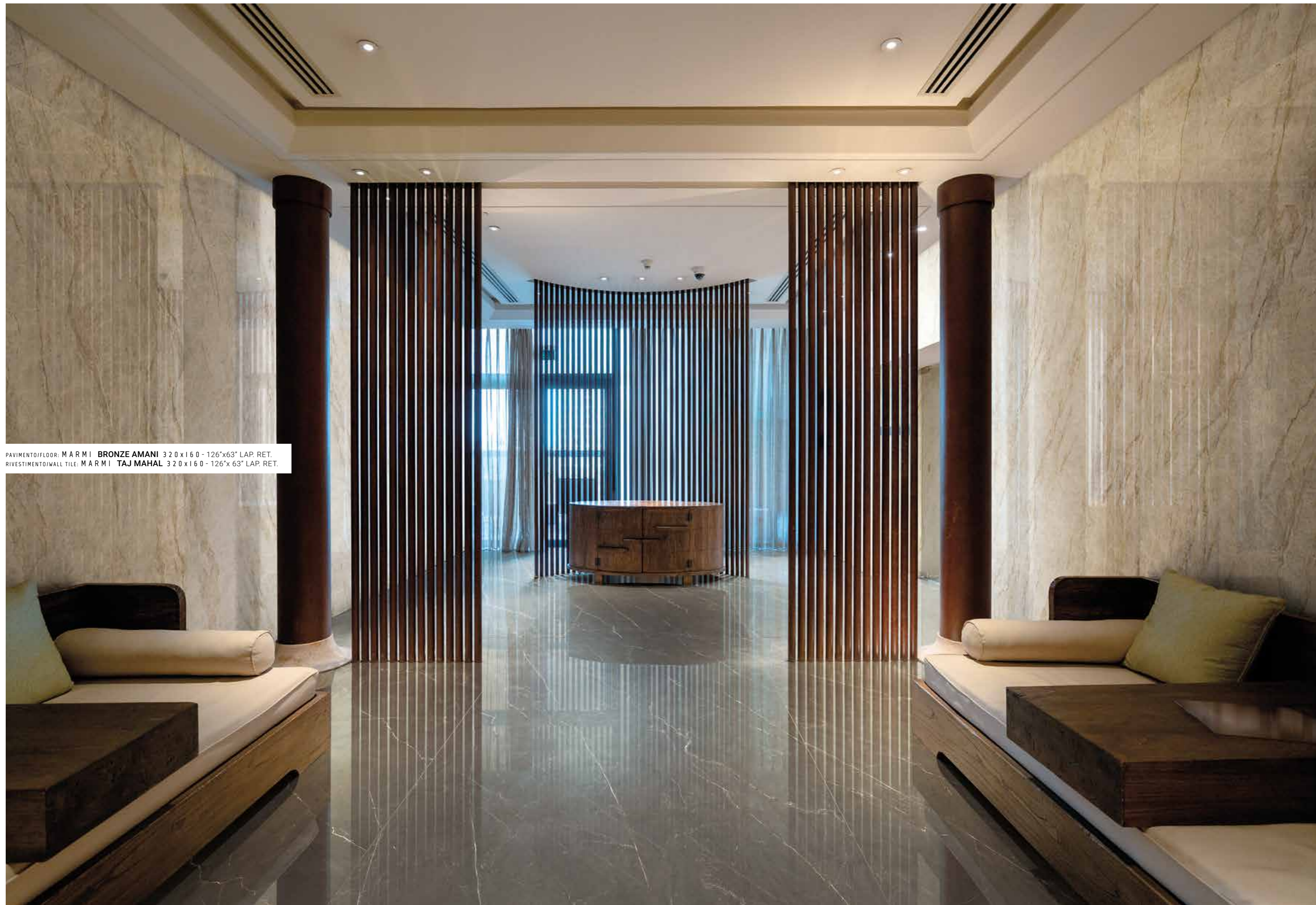

PAVIMENTO/FLOOR: M A R M I **BRONZE AMANI** 3 2 0 x 1 6 0 - 126"x63" LAP. RET.
RIVESTIMENTO/WALL TILE: M A R M I **TAJ MAHAL** 3 2 0 x 1 6 0 - 126"x 63" LAP. RET.

324x163

127"x64"

12 mm

1/2"

- Lap. Nat.
- Nat.

BARDIGLIO CENERE

320x160

126"x63"

6 mm

1/4"

- Nat. Ret.
- Lap. Ret.

324x163

127"x64"

12 mm

1/2"

- Lap. Nat.

*

BRONZE AMANI

320x160

126"x63"

6 mm

1/4"

- Lap. Ret.

*

Disponibile con ordine minimo di 1.200 m²

Available with minimum order of 1,200 m².
Quantité minimale par commande 1200 m².
Erhältlich bei einer Mindestbestellmenge von 1.200 m².
Disponibile bajo pedido mínimo de 1.200 m².
При минимальном заказе от 1200 м².
最少订购1,200平方米

MARMI

BARDIGLIO CENERE. BRONZE AMANI.

LASTRE IN GRES PORCELLANATO PRESSATE A SECCO

Dry-pressed porcelain stoneware slabs. Dalles en grès cérame pressées à sec. Trockengepresste Platten aus Feinsteinzeug. Planchas en gres porcelánico prensadas en seco. Керамогранитные плиты сухого прессования. 干压陶瓷砖

Spessore. Thickness. Epaisseur. Stärke. Espesor. Толщина. 厚度 6mm - 10mm - 12mm - 12mm*

UNI EN 14411-ISO 13006 appendice G gruppo BIa - UGL











Grande varietà nelle grafiche per un pavimento o rivestimento sempre vario a effetto "naturale" - The collection is available in a wide variety of graphics for varied floor or wall solutions with a "natural" effect. Grande variété des graphiques pour un carrelage de sol ou un revêtement mural toujours différent et un effet "naturel". - Große Vielfalt der Graphiken für einen ständig unterschiedlichen Boden- oder Wandbelag mit "natürlichem" Effekt. - Gran variedad en las gráficas para un pavimento o revestimiento siempre diferente de efecto "natural". - Предлагается большое разнообразие рисунков для укладки всегда меняющегося пола или облицовки с натуральным эффектом. * 多样的图案让地板和涂层具有不同的“天然”色彩。



BARDIGLIO CENERE

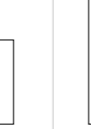

BRONZE AMANI

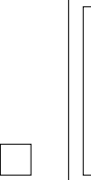
													
		320x160 126"x63" 6 mm	160x160 63"x63" 6 mm	280x120 110"x48" 6 mm	240x120 96"x48" 6 mm	120x120 48"x48" 6 mm	160x80 63"x31 1/2" 6 mm	240x80 96"x31 1/2" 6 mm	80x80 31 1/2"x31 1/2" 6 mm	100x100 40"x40" 10 mm	120x60 48"x24" 10 mm	60x60 24"x24" 10 mm	324x163 127"x64" 12 mm
Bardiglio Cenere	□ Nat. Ret.	087006 M173	087046 M161	-	087026 M153	087066 M141	087086 M141	-	087106 M125	-	087126 M109	087146 M089	-
	○ Lap. Ret.	087005 M197	087045 M187	-	087025 M175	087065 M169	087085 M169	087533 M175	087105 M139	-	087125 M125	087145 M113	-
	■ Nat.	-	-	-	-	-	-	-	-	-	-	-	087906 M221
	● Lap. Nat.	-	-	-	-	-	-	-	-	-	-	-	087905 M247
Bronze Amani	○ Lap. Ret.	148002 M197	148042 M187	148022 M175	-	-	148082 M169	-	148102 M139	-	-	-	● Lap. Nat.*

Il formato 324x163 in 12 mm è prodotto senza stuoia. La stuoia potrà essere aggiunta solo su specifica richiesta. Lo spessore delle lastre stuoiate è di 12,7 mm. The 324x163 size 12 mm thickness is produced without the fiber glass mesh. The fiber glass mesh will be supplied only on demand. The thickness of the mesh-mounted is 12,7 mm

* **Disponibile con ordine minimo di 1.200 m²**. Available with minimum order of 1,200 m². Quantité minimale par commande 1200 m². Erhältlich bei einer Mindestbestellmenge von 1.200 m². Disponible bajo pedido mínimo de 1.200 m². При минимальном заказе от 1200 м². 最少订购1,200平方米

○ **Lappato e rettificato.** Lappato and rectified. Lappato et rectifié. Lappato und kalibriert. Lappato y rectificado. Лаппатированный ректифицированный. 亚光和抛光。

□ **Naturale e rettificato.** Natural and rectified. Naturel et rectifié. Natur Oberfläche und kalibriert. Natural y rectificado. Натуральный ректифицированный. 天然和抛光。

● **Lappato con bordi naturali.** Lappato with non rectified edges. Lappato à bords naturels. Lappato mit natürlichen Kanten. Pulido con los bordes natural. Лаппатированная поверхность с матовой кромкой. 抛光电天然磨边。

■ **Naturale.** Natural. Naturel. Natur natur. Natural. Натуральный. 天然。

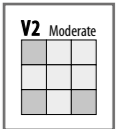

WET DYNAMIC COEFFICIENT OF FRICTION
DCOF ≥ 0,42

SOLO SUPERFICIE NATURALE
Only natural surface

CALACATTA
CREMA MARFIL



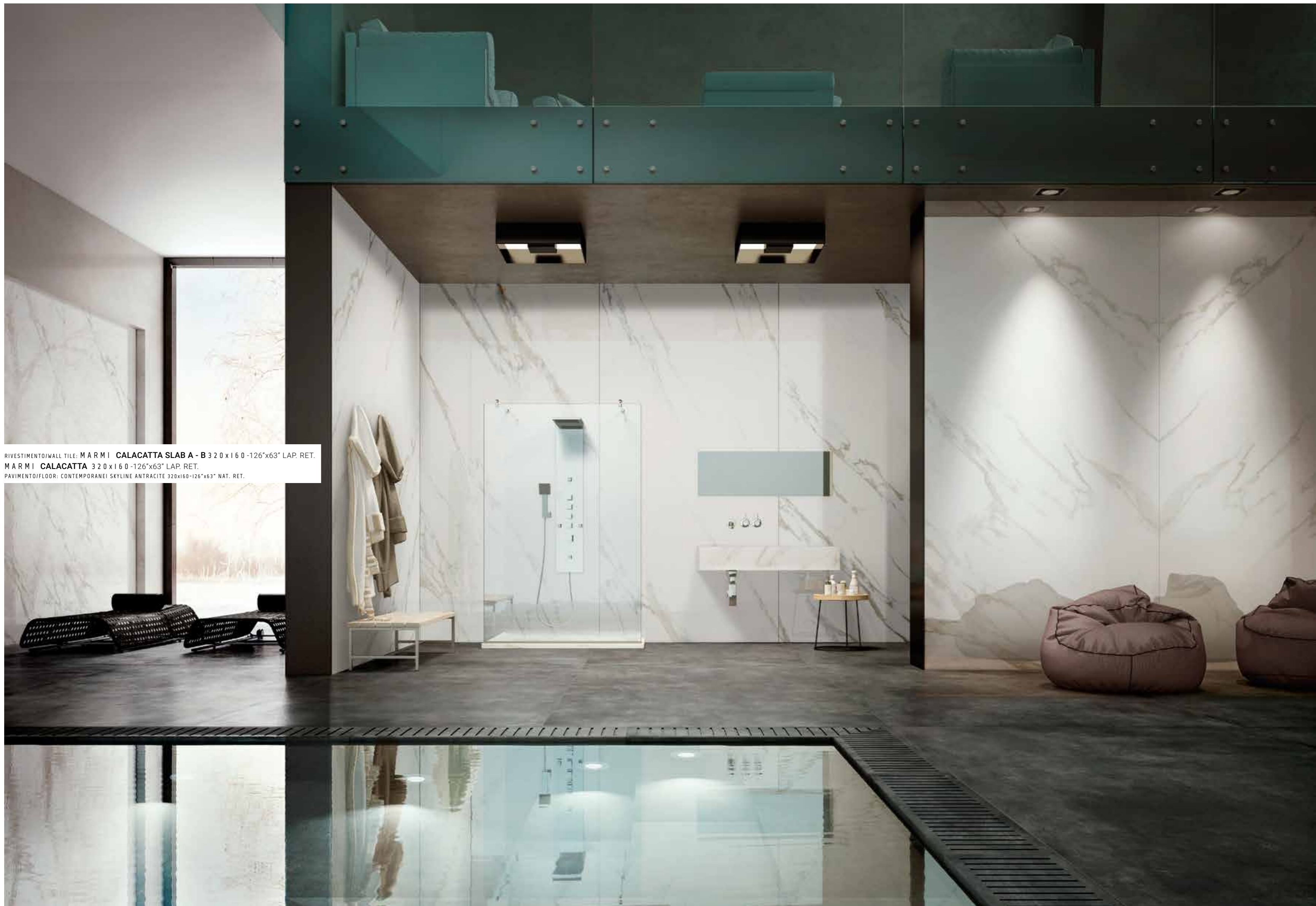

RIVESTIMENTO/WALL TILE: M A R M I CALACATTA SLAB A - B 3 2 0 x 1 6 0 -126"x63" LAP. RET.
M A R M I CALACATTA 3 2 0 x 1 6 0 -126"x63" LAP. RET.
PAVIMENTO/FLOOR: CONTEMPORANEI SKYLINE ANTRACITE 320x160-126"x63" NAT. RET.





324x163
127"x64"
12 mm
1/2"

- Lap. Nat.
- Nat.

CALACATTA

320x160
126"x63"
6 mm
1/4"

- Nat. Ret.
- Lap. Ret.

324x163
127"x64"
12 mm
1/2"

- Lap. Nat.
- Nat.

★

CREMA MARFIL

320x160
126"x63"
6 mm
1/4"

- Nat. Ret.
- Lap. Ret.

★

Disponibile con ordine minimo di 1.200 m²

Available with minimum order of 1,200 m².
Quantité minimale par commande 1200 m².
Erhältlich bei einer Mindestbestellmenge von 1.200 m².
Disponibile bajo pedido mínimo de 1.200 m².
При минимальном заказе от 1200 м².
最少订购1,200平方米

MARMI

CALACATTA. CREMA MARFIL.

LASTRE IN GRES PORCELLANATO PRESSATE A SECCO

Dry-pressed porcelain stoneware slabs. Dalles en grès cérame pressées à sec. Trockengepresste Platten aus Feinsteinzeug. Planchas en gres porcelánico prensadas en seco. Керамогранитные плиты сухого прессования. 干压陶瓷砖

Spessore. Thickness. Epaisseur. Stärke. Espesor. Толщина. 厚度 **6mm - 10mm - 12mm - 12mm***

UNI EN 14411-ISO 13006 appendice G gruppo Bla - UGL

Grande varietà nelle grafiche per un pavimento o rivestimento sempre vario a effetto "naturale" - The collection is available in a wide variety of graphics for varied floor or wall solutions with a "natural" effect. Grande variété des graphiques pour un carrelage de sol ou un revêtement mural toujours différent et un effet "naturel" - Große Vielfalt der Graphiken für einen ständig unterschiedlichen Boden- oder Wandbelag mit "natürlichem" Effekt. - Gran variedad en las gráficas para un pavimento o revestimiento siempre diferente de efecto "natural". - Предлагается большое разнообразие рисунков для укладки всегда меняющегося пола или облицовки с натуральным эффектом. - 多样的图案让地板和涂层具有不同的“天然”色彩。

V2 Moderate

ANSI A 137.1: 2012

WET DYNAMIC COEFFICIENT OF FRICTION

DCOF ≥ 0,42

SOLO SUPERFICIE NATURALE
Only natural surface

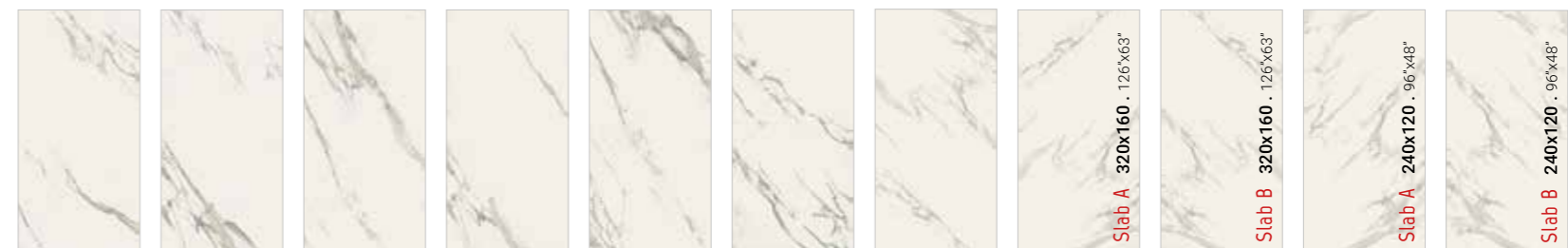

CALACATTA

CALACATTA Slab A

CALACATTA Slab B

CALACATTA Slab A

CALACATTA Slab B



CREMA MARFIL

		320x160 126"x63" 6 mm	160x160 63"x63" 6 mm	280x120 110"x48" 6 mm	240x120 96"x48" 6 mm	120x120 48"x48" 6 mm	160x80 63"x31 1/2" 6 mm	240x80 96"x31 1/2" 6 mm	80x80 31 1/2"x31 1/2" 6 mm	100x100 40"x40" 10 mm	120x60 48"x24" 10 mm	60x60 24"x24" 10 mm	324x163 127"x64" 12 mm
Calacatta	□ Nat. Ret.	083006 M173	083026 M161	-	083016 M153	083036 M141	083046 M141	-	083056 M125	-	083066 M109	083086 M089	-
	○ Lap. Ret.	083005 M197	083025 M187	-	083015 M175	083035 M169	083045 M169	-	083055 M139	-	083065 M125	083085 M113	-
	■ Nat.	-	-	-	-	-	-	-	-	-	-	-	083902 M221
	● Lap. Nat.	-	-	-	-	-	-	-	-	-	-	-	083901 M247
Slab A	○ Lap. Ret.	083093 M197	-	-	083112 M175	-	-	-	-	-	-	-	-
	○ Lap. Ret.	083094 M197	-	-	083113 M175	-	-	-	-	-	-	-	-
Crema Marfil	□ Nat. Ret.	083010 M173	083030 M161	-	083020 M153	083040 M141	083050 M141	-	083060 M125	-	083070 M109	083088♦ M089	■ Nat.*
	○ Lap. Ret.	083009 M197	083029 M187	-	083019 M175	083039 M169	083049 M169	083557 M175	083059 M139	-	083069 M125	083087♦ M113	● Lap. Nat.*

Il formato 324x163 in 12 mm è prodotto senza stuoia. La stuoia potrà essere aggiunta solo su specifica richiesta. Lo spessore delle lastre stuoiate è di 12,7 mm. The 324x163 size 12 mm thickness is produced without the fiber glass mesh. The fiber glass mesh will be supplied only on demand. The thickness of the mesh-mounted is 12,7 mm

- ★ **Disponibile con ordine minimo di 1.200 m²**. Available with minimum order of 1,200 m². Quantité minimale par commande 1200 m². Erhältlich bei einer Mindestbestellmenge von 1.200 m². Disponible bajo pedido mínimo de 1.200 m². При минимальном заказе от 1200 м². 最少订购1,200平方米
- ♦ **Disponibile con ordine minimo di 2.000 m²**. Available with minimum order of 2,000 m². Quantité minimale par commande 2000 m². Erhältlich bei einer Mindestbestellmenge von 2.000 m². Disponible bajo pedido mínimo de 2.000 m². При минимальном заказе от 2000 м². 最少订购2,000平方米

- **Lappato e rettificato.** Lappato and rectified. Lappato et rectifié. Lappato und kalibriert. Lappato y rectificado. Лаппатированный ректифицированный. 亚光和抛光。
- **Naturale e rettificato.** Natural and rectified. Naturel et rectifié. Natur Oberfläche und kalibriert. Natural y rectificado. Натуральный ректифицированный. 天然和抛光。
- **Lappato con bordi naturali.** Lappato with non rectified edges. Lappato à bords naturels. Lappato mit natürlichen Kanten. Pulido con los bordes natural. Лаппатированная поверхность с матовой кромкой. 抛光带天然磨边。
- **Naturale.** Natural. Naturel. Natur natur. Natural. Натуральный. 天然。

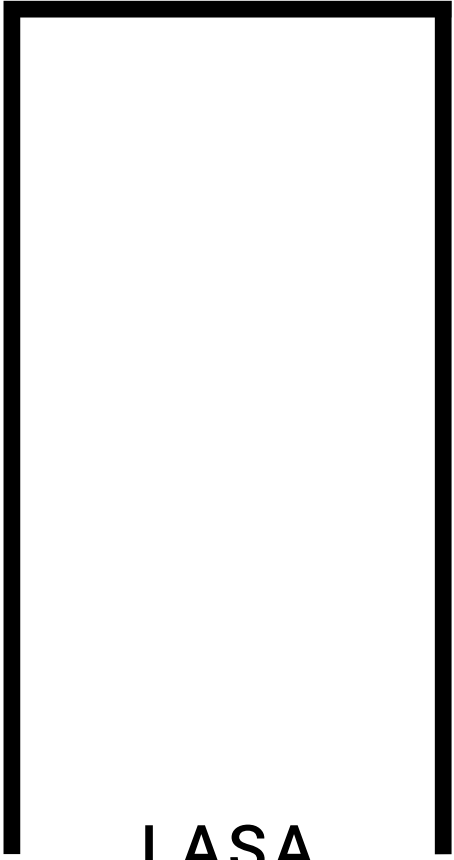

LASA

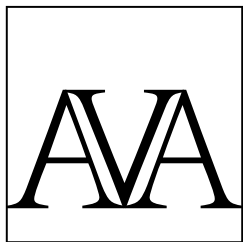

LASA
— M A R M I —



ABOUT LASA

Lasa è una pietra calcarea cristallizzata, segnata dal tempo da rade striature di grigio. Il fondo, di un bianco luminoso ed omogeneo, rende il Lasa un marmo di grande fascino che soddisfa le più elevate esigenze di stile e funzionali.

Vista la sua ampia applicazione in diversi ambienti e contesti, AVA ha deciso di integrare la gamma con lastre dello spessore di 10 mm nel nuovo formato 180x80, in finitura sia naturale sia lappata.



MARMI / wall and floor: lasa 320x160-126"x63" LAP. RET.
TOP MARMI AZUL MACAUBA LAP. RET.

Lasa is a crystallised calcareous stone marked by time with sparse grey streaks. The background is a luminous and homogeneous white, making Lasa a particularly appealing marble that meets even the most discriminating demands for style and function.

Given its wide range of use in different settings and contexts, AVA decided to integrate the Lasa range with 10-mm thick slabs in the new 180x80 format, in both natural and lapped finishes.

Le lasa est un calcaire cristallisé, marqué par le temps par des stries grises clairsemées. Grâce au fond d'un blanc lumineux et homogène, le Lasa est un marbre de grand charme qui répond aux plus hautes exigences de style et de fonctionnalité. Compte tenu de sa large application dans différents environnements et contextes, AVA a décidé d'ajouter à la gamme des dalles de 10 mm d'épaisseur dans le nouveau format 180x80, en finition naturelle et rodée.

Lasa ist ein kristallisierter Kalkstein, der im Laufe der Zeit von wenigen grauen Schlieren durchzogen wurde. Der gleichmäßige, leuchtend weiße Hintergrund verleiht dem Lasa-Marmor eine faszinierende Ästhetik, die höchste stilistische und funktionale Ansprüche erfüllt.

Da diese Optik sich perfekt für unterschiedlichste Anwendungen und Umgebungen eignet, hat AVA die 10 mm dicken Platten der Serie durch ein neues Format mit den Maßen 180x80 ergänzt, das sowohl in der Ausführung natur als auch anpoliert erhältlich ist.

Lasa es una piedra calcárea cristalizada, marcada por el tiempo con estriados raros de color gris. El fondo blanco, luminoso y homogéneo, hace de Lasa un mármol de gran encanto que satisface las más elevadas exigencias funcionales y de estilo.

Dada su extensa aplicación a diferentes ambientes y contextos, AVA decidió integrar la gama con placas de 10 mm de espesor en el nuevo formato 180x80, con acabado tanto natural como lapado.

Lasa - это известковый кристаллический камень, на котором время оставило свой след в виде редких серых полос. Яркий и однородный белый фон придает мрамору Lasa особое очарование, благодаря которому этот материал способен удовлетворить самые высокие требования, предъявляемые к стилю и функциональности.

Поскольку этот продукт можно применять в разной среде и в разных условиях, AVA решила дополнить ассортимент плитой толщиной 10 мм в новом формате 180x80 в натуральном и лаппатированном варианте.

拉萨 Lasa 是一种结晶的石灰石，稀疏的灰色条纹带着时间感。明亮而均匀的白色基底使拉萨 Lasa 成为一种极富魅力的大理石，以满足高级风格与功能的需求。

鉴于它在不同环境和氛围中的广泛应用，AVA 决定将该系列产品与 10 毫米厚度，抛光表面和自然表面的新型 180x80 板材结合在一起。

LASA

MARMI

LASTRE IN GRES PORCELLANATO PRESSATE A SECCO

Dry-pressed porcelain stoneware slabs. Dalles en grès cérame pressées à sec. Trockengepresste Platten aus Feinsteinzeug. Planchas en gres porcelánico prensadas en seco. Керамогранитные плиты сухого прессования. 干压陶瓷砖

UNI EN 14411-ISO 13006 appendice C gruppo Bla - UGL

SHADE SPECTRUM

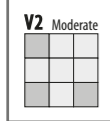

ANSI A 137.1: 2012
WET DYNAMIC COEFFICIENT OF FRICTION
DCOF ≥ 0,42

SOLO SUPERFICIE NATURALE
Only Natural Surface

Spessore.
Thickness.
Épaisseur.
Stärke.
Espesor.
Толщина.
厚度。



Naturale e rettificato.
Natural and rectified.
Naturel et rectifié.
Natur Oberfläche und kalibriert.
Natural y rectificado.
Натуральный ректифицированный.
天然和抛光。

Lappato e rettificato.
Lappato and rectified.
Lappato et rectifié.
Lappato und kalibriert.
Lappato y rectificado.
Лаппатированный ректифицированный.
亚光和抛光。

Lappato con bordi naturali.
Lappato with non rectified edges.
Lappato à bords naturels.
Lappato mit natürlichen Kanten.
Pulido con los bordes natural.
Лаппатированная поверхность с матовой кромкой.
抛光带天然磨边。

Naturale.
Natural.
Naturel.
Natur natur.
Natural.
Натуральный.
天然。

■ NAT. ● LAP.

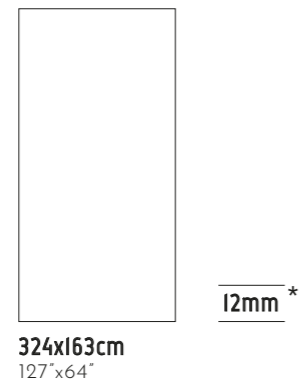

NAT. RET. LAP. RET.

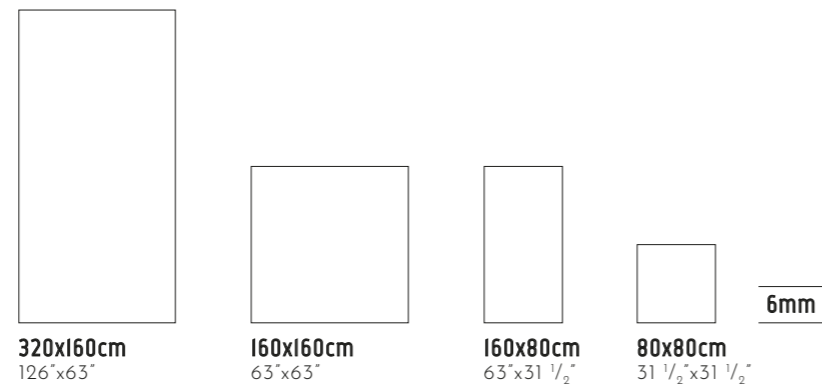

MODULAR SYSTEM

NAT. RET. LAP. RET.

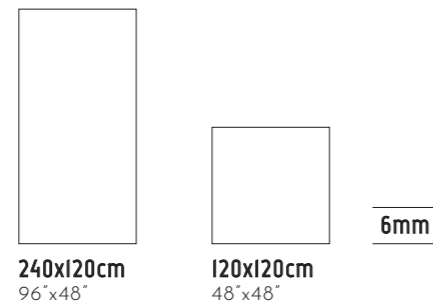

MODULAR SYSTEM

NAT. RET. LAP. RET.

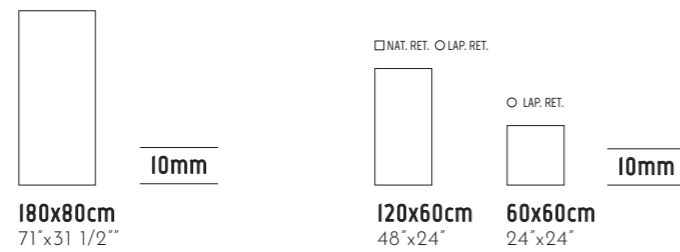

MODULAR SYSTEM

* Disponibile con ordine minimo di 1.200 m².
Available with minimum order of 1.200 m². Quantité minimale par commande 1200 m².
Erhältlich bei einer Mindestbestellmenge von 1.200 m². Disponible bajo pedido mínimo de 1.200 m². При минимальном заказе от 1200 м². 最少订购1,200平方米。



LASA

100% DESIGN
AND PRODUCTION
OF ITALY

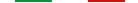

LASA

MARMI

LASTRE IN GRES PORCELLANATO PRESSATE A SECCO

Dry-pressed porcelain stoneware slabs. Dalles en grès cérame pressées à sec. Trockengepresste Platten aus Feinsteinzeug. Planchas en gres porcelánico prensadas en seco. Керамогранитные плиты сухого прессования. 干压陶瓷砖

UNI EN 14411-ISO 13006 appendice C gruppo B1a - UGL

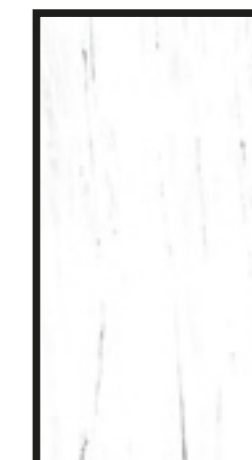
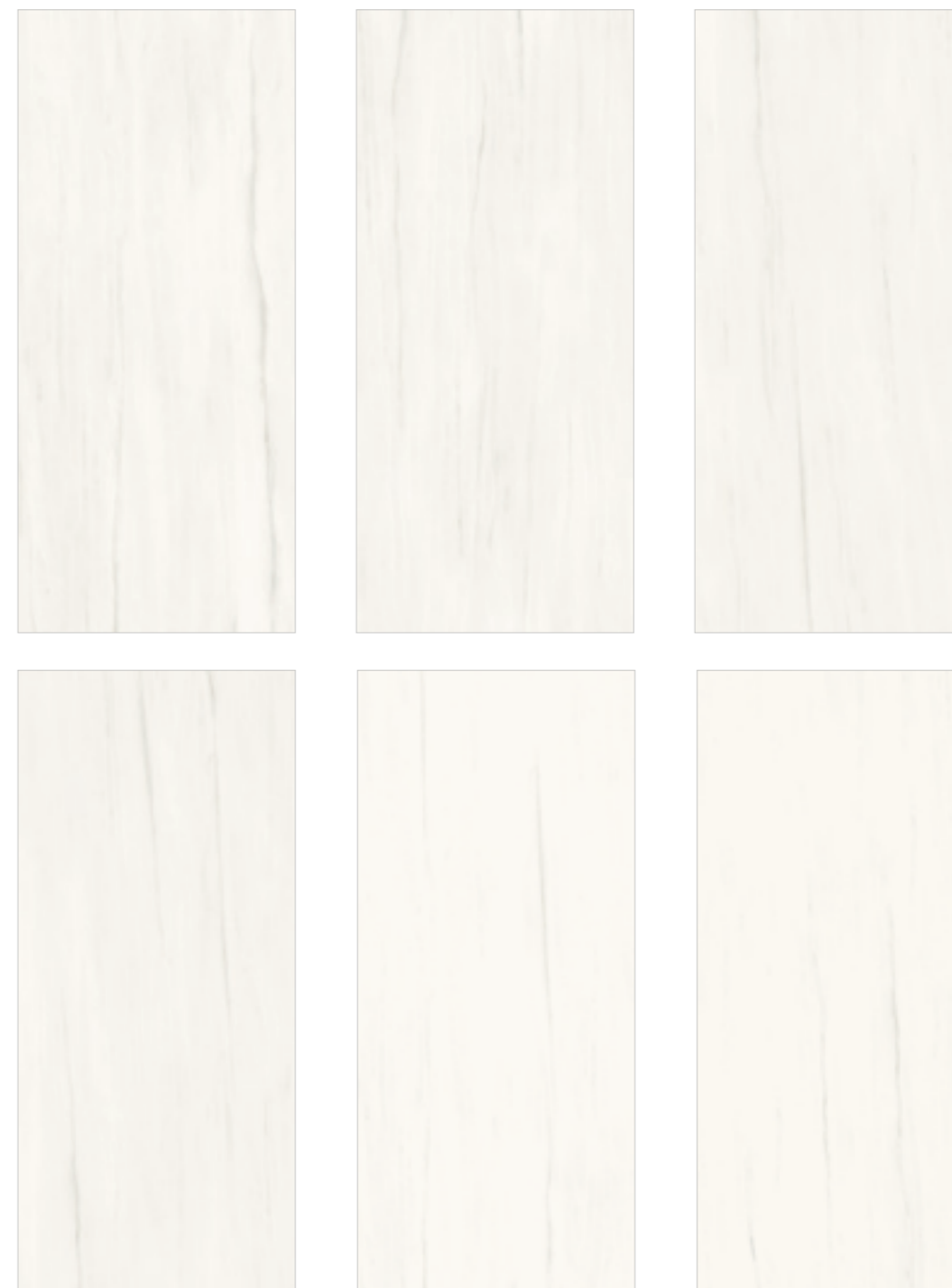

LASA

Grafiche Diverse.

Different patterns (based on size). Différents graphismes par format. Je nach Format verschiedene Grafifiken. Gráficas diferentes según formato. Кол. вариантов графики для каждого формата. 不同格式的图形.

7	7	14	28	56
324x163	320x160	160x160	160x80	80x80
11	22	14	21	42
240x120	120x120	180x80 NEW	120x60	60x60





MARMI / wall and floor: lasa 180x80-71'x31 1/2' LAP. RET.

LASA

MARMI

LASTRE IN GRES PORCELLANATO PRESSATE A SECCO

Dry-pressed porcelain stoneware slabs. Dalles en grès cérame pressées à sec. Trockengepresste Platten aus Feinsteinzeug.

Planchas en gres porcelánico prensadas en seco. Керамогранитные плиты сухого прессования. 干压陶瓷砖

UNI EN 14411-ISO 13006 appendice C gruppo Bla - UGL

Spessore. Thickness. Épaisseur. Stärke. Espesor. Толщина. 厚度 **6 mm - 10 mm - 12 mm***

Mxxx: Codice prezzo al mq. Sqm price code. Code prix au mq. Kode Preis pro Qm. Código de precio por metro cuadrado. цена за шт. 每平方米价格代码

	MODULAR SYSTEM				MODULAR SYSTEM				MODULAR SYSTEM	
	320x160 126"x63" 6 mm	160x160 63"x63" 6 mm	160x80 63"x31 1/2" 6 mm	80x80 31 1/2"x31 1/2" 6 mm	240x120 96"x48" 6 mm	120x120 48"x48" 6 mm	180x80 71"x31 1/2" 10 mm	120x60 48"x24" 10 mm	60x60 24"x24" 10 mm	324x163 127"x64" 12 mm*
□ Nat. Ret.	087004 M173	087044 M161	087084 M141	087104 M125	087024 M153	087064 M141	087615 M125	087124 M109	087144 M089	-
○ Lap. Ret.	087003 M197	087043 M187	087083 M169	087103 M139	087023 M175	087063 M169	087612 M143	087123 M125	087143 M113	-
● Nat.	-	-	-	-	-	-	-	-	-	087907 M221
● Lap. Nat.	-	-	-	-	-	-	-	-	-	087914 M247

Il formato 324x163 in 12 mm è prodotto senza stuoia. La stuoia potrà essere aggiunta solo su specifica richiesta. Lo spessore delle lastre stuoiate è di 12,7 mm. The 324x163 size 12 mm thickness is produced without the fiber glass mesh. The fiber glass mesh will be supplied only on demand. The thickness of the mesh-mounted is 12,7 mm

* Disponibile con ordine minimo di 1.200 m². Available with minimum order of 1,200 m². Quantité minimale par commande 1200 m². Erhältlich bei einer Mindestbestellmenge von 1.200 m². Disponible bajo pedido mínimo de 1.200 m². При минимальном заказе от 1200 м². 最少订购1,200平方米

DECORI

Decors. Décors. Dekore. Decoraciones. Декоры. 饰

MOSAICO

30x30cm. 12"x12"

thickness 6mm

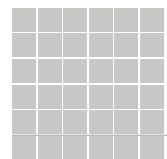

087193 ○ Lap. Ret. **M235** | 087194 □ Nat. Ret. **M193**

○ Lappato e rettificato. Lappato and rectified. Lappato et rectifié. Lappato und kalibriert. Lappato y rectificado. Лаппатированный ректифицированный. 亚光和抛光。

□ Naturale e rettificato. Natural and rectified. Naturel et rectifié. Natur Oberfläche und kalibriert. Natural y rectificado. Натуральный ректифицированный. 天然和抛光。

● Lappato con bordi naturali. Lappato with non rectified edges. Lappato à bords naturels. Lappato mit natürlichen Kanten. Pulido con los bordes natural. Лаппатированная поверхность с матовой кромкой. 抛光带天然磨边。

■ Naturale. Natural. Naturel. Natur natur. Natural. Натуральный. 天然。

** PEZZI SPECIALI

Trims . Pièces spéciales . Formstücke . Piezas especiales . Специальные элементы. 特别部件

Pxxx: Codice prezzo al pezzo. Code price per piece. Code prix à la pièce. Kode Preis pro Stück. Código de precio por unidades. цена за шт. 每片价格代码

COSTA RETTA:

Straight nose:

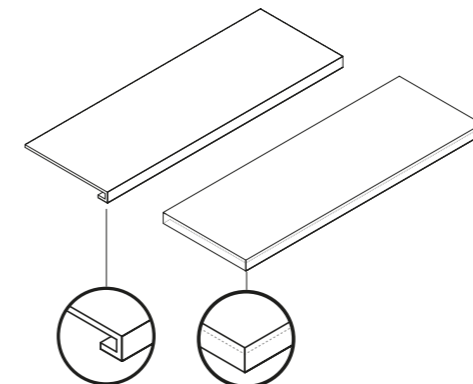

Gradino costa retta
Straight nosed stair

Gradino costa retta angolo
Straight nosed corner step

BORDO DRITTO:

Straight edge:

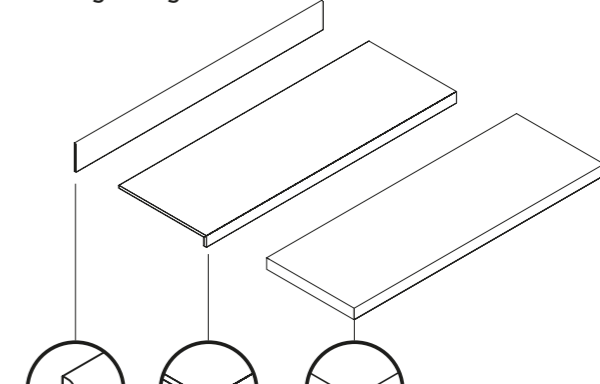

Battiscopa
Skirting

Gradino bordo dritto
Straight-edge step

Gradino bordo dritto angolo
Straight-edge corner step

	Battiscopa 120x6,5 48"x2 1/2" 10mm	Battiscopa 80x8 31 1/2"x3" 6mm
○ Lap. Ret.	087213 P033	087203 P029
□ Nat. Ret.	087214 P029	087204 P025

	Gradino costa retta 160x33x3,2 63"x13"x1 1/4" 6 mm	Gradino costa retta 160x33x3,2 63"x13"x1 1/4" 6 mm	Gradino costa retta 120x33x3,2 48"x13"x1 1/4" 6 mm	Gradino costa retta 120x33x3,2 48"x13"x1 1/4" 6 mm	Gradino costa retta 80x33x3,2 31 1/2"x13"x1 1/4" 6 mm	Gradino costa retta 80x33x3,2 31 1/2"x13"x1 1/4" 6 mm	Gradino costa retta 120x33x3,2 48"x13"x1 1/4" 10 mm	Gradino costa retta 120x33x3,2 48"x13"x1 1/4" 10 mm
○ Lap. Ret.	087312 P323	087313 DX 087314 SX P339	087345 P265	087346 DX 087347 SX P283	087372 P175	087373 DX 087374 SX P215	087239 P215	087399 DX 087400 SX P243
□ Nat. Ret.	087315 P303	087316 DX 087317 SX P319	087348 P243	087349 DX 087350 SX P273	087238 P167	087375 DX 087376 SX P203	087401 P207	087402 DX 087403 SX P231

	Gradino bordo dritto 160x30x4h 63"x12"x1 1/4" 6 mm	Gradino bordo dritto 160x30x4h 63"x12"x1 1/4" 6 mm	Gradino bordo dritto 120x30x4h 48"x12"x1 1/4" 6 mm	Gradino bordo dritto 120x30x4h 48"x12"x1 1/4" 6 mm	Gradino bordo dritto 80x30x4h 31 1/2"x12"x1 1/4" 6 mm	Gradino bordo dritto 80x30x4h 31 1/2"x12"x1 1/4" 6 mm	Gradino bordo dritto 120x30x4h 48"x12"x1 1/4" 10 mm	Gradino bordo dritto 120x30x4h 48"x12"x1 1/4" 10 mm
○ Lap. Ret.	087656 P267	087423 DX 087424 SX P305	087451 P201	087452 DX 087453 SX P257	087494 P143	087495 DX 087496 SX P197	087634 P179	087526 DX 087635 SX P201
□ Nat. Ret.	087242 P245	087425 DX 087426 SX P287	087454 P193	087455 DX 087456 SX P245	087497 P135	087498 DX 087499 SX P183	087527 P173	087529 DX 087528 SX P201

** A disposizione solo su richiesta. Tempi di consegna: 30gg. Available upon request only. Delivery terms: 30 days. Disponible seulement sur requête. Délais de livraison: 30 jours. Verfügbar auf Anfrage. Lieferzeit: 30 Tage. Disponible sólo bajo pedido. Plazo de entrega: 30 días. Изготавливается только по специальной заявке. Срок поставки: 30 дней. 仅依订购。交货时间: 30日。

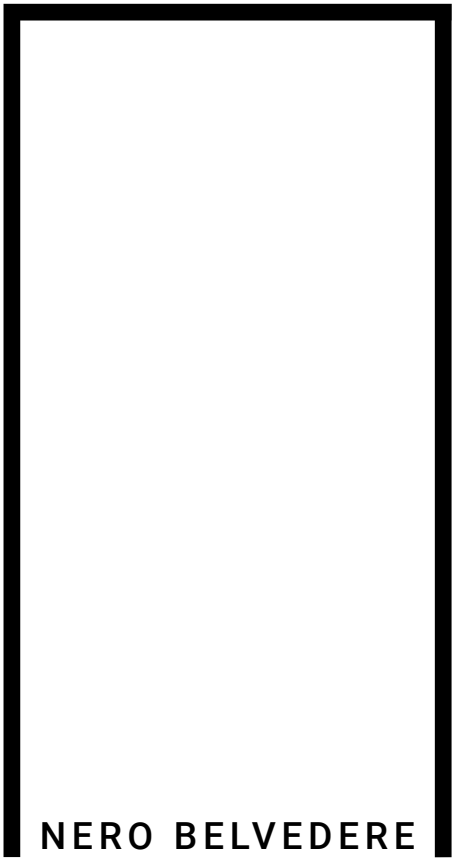

NERO BELVEDERE

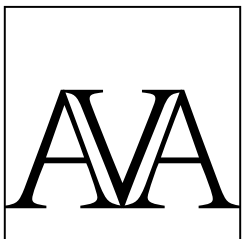



PAVIMENTO/FLOOR: M A R M I NERO BELVEDERE 3 2 0 x 1 6 0 - 126"x 63" LAP. RET.
RIVESTIMENTO/WALL TILE: MARM I STATUARIO SPLENDEnte 320x160-126"x 63" LAP. RET.
MARM I STATUARIO SPLENDEnte SLAB A - B 320x160-126"x 63" LAP. RET.

324x163
127"x64"
12 mm
1/2"

- Lap. Nat.
 - Nat.
- ***

LASA

320x160
126"x63"
6 mm
1/4"

- Nat. Ret.
- Lap. Ret.

324x163
127"x64"
12 mm
1/2"

- Lap. Nat.
- ***

NERO BELVEDERE

320x160
126"x63"
6 mm
1/4"

- Lap. Ret.

Disponibile con ordine minimo di 1.200 m²

Available with minimum order of 1,200 m².
Quantité minimale par commande 1200 m².
Erhältlich bei einer Mindestbestellmenge von 1.200 m².
Disponible bajo pedido mínimo de 1.200 m².
При минимальном заказе от 1200 м².
最少订购1,200平方米

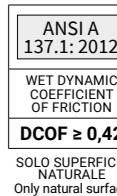
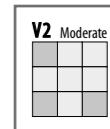

MARMI

LASA. NERO BELVEDERE.

LASTRE IN GRES PORCELLANATO PRESSATE A SECCO

Dry-pressed porcelain stoneware slabs. Dalles en grès cérame pressées à sec. Trockengepresste Platten aus Feinsteinzeug. Planchas en gres porcelánico prensadas en seco. Керамогранитные плиты сухого прессования. 干压陶瓷砖

Spessore. Thickness. Epaisseur. Stärke. Espesor. Толщина. 厚度 **6mm - 10mm - 12mm***

UNI EN 14411-ISO 13006 appendice G gruppo Bla - UGL

Grande varietà nelle grafiche per un pavimento o rivestimento sempre vario a effetto "naturale" - The collection is available in a wide variety of graphics for varied floor or wall solutions with a "natural" effect. Grande variété des graphiques pour un carrelage de sol ou un revêtement mural toujours différent et un effet "naturel" - Große Vielfalt der Graphiken für einen ständig unterschiedlichen Boden- oder Wandbelag mit "natürlichem" Effekt. - Gran variedad en las gráficas para un pavimento o revestimiento siempre diferente de efecto "natural". - Предлагается большое разнообразие рисунков для укладки всегда меняющегося пола или облицовки с натуральным эффектом. * 多样的图案让地板和涂层具有不同的“天然”色彩。



LASA



NERO BELVEDERE

		320x160 126"x63" 6 mm	160x160 63"x63" 6 mm	280x120 110"x48" 6 mm	240x120 96"x48" 6 mm	120x120 48"x48" 6 mm	160x80 63"x31 1/2" 6 mm	240x80 96"x31 1/2" 6 mm	80x80 31 1/2"x31 1/2" 6 mm	100x100 40"x40" 10 mm	120x60 48"x24" 10 mm	60x60 24"x24" 10 mm	324x163 127"x64" 12 mm*
Lasa	□ Nat. Ret.	087004 M173	087044 M161	-	087024 M153	087064 M141	087084 M141	-	087104 M125	-	087124 M109	087144 M089	■ Nat.
	○ Lap. Ret.	087003 M197	087043 M187	-	087023 M175	087063 M169	087083 M169	-	087103 M139	-	087123 M125	087143 M113	● Lap. Nat.
Nero Belvedere	○ Lap. Ret.	087013 M197	087049 M187	-	087033 M175	087069 M169	087089 M169	-	087109 M139	-	087129 M125	087149 M113	● Lap. Nat.

Il formato 324x163 in 12 mm è prodotto senza stuoia. La stuoia potrà essere aggiunta solo su specifica richiesta. Lo spessore delle lastre stuoiate è di 12,7 mm. The 324x163 size 12 mm thickness is produced without the fiber glass mesh. The fiber glass mesh will be supplied only on demand. The thickness of the mesh-mounted is 12,7 mm

* Disponibile con ordine minimo di 1.200 m². Available with minimum order of 1,200 m². Quantité minimale par commande 1200 m². Erhältlich bei einer Mindestbestellmenge von 1.200 m². Disponible bajo pedido mínimo de 1.200 m². При минимальном заказе от 1200 м². 最少订购1,200平方米

- Lappato e rettificato. Lappato and rectified. Lappato et rectifié. Lappato und kalibriert. Lappato y rectificado. Лаппатированный ректифицированный. 亚光和抛光。
- Naturale e rettificato. Natural and rectified. Naturel et rectifié. Natur Oberfläche und kalibriert. Natural y rectificado. Натуральный ректифицированный. 天然和抛光。
- Lappato con bordi naturali. Lappato with non rectified edges. Lappato à bords naturels. Lappato mit natürlichen Kanten. Pulido con los bordes natural. Лаппатированная поверхность с матовой кромкой. 抛光带天然磨边。
- Naturale. Natural. Naturel. Natur natur. Natural. Натуральный. 天然。

STATUARIO

STATUARIO
SPLENDEnte





RIVESTIMENTO/WALL TILE: M A R M I STATUARIO SLAB A - B 3 2 0 x 1 6 0 - 126"x63" LAP. RET.
RIVESTIMENTO PARETE SX/LEFT WALL TILE: M A R M I STATUARIO 3 2 0 x 1 6 0 - 126"x63" LAP. RET.
PAVIMENTO/FLOOR: M A R M I STATUARIO 1 6 0 x 1 6 0 - 63"x63" LAP. RET.



PAVIMENTO/FLOOR: M A R M I STATUARIO SPLENDEnte 3 2 0 x 1 6 0 - 126"x63" LAP. RET.
RIVESTIMENTO/WALL TILE: M A R M I STATUARIO SPLENDEnte SLAB A - B 3 2 0 x 1 6 0 - 126"x63" LAP. RET.

TAJ MAHAL
TRAVERTINO
CLASSICO





PAVIMENTO E RIVESTIMENTO/FLOOR AND WALL TILE
M A R M I TAJ MAHAL 3 2 0 x 1 6 0 - 126"x 63" LAP. RET.

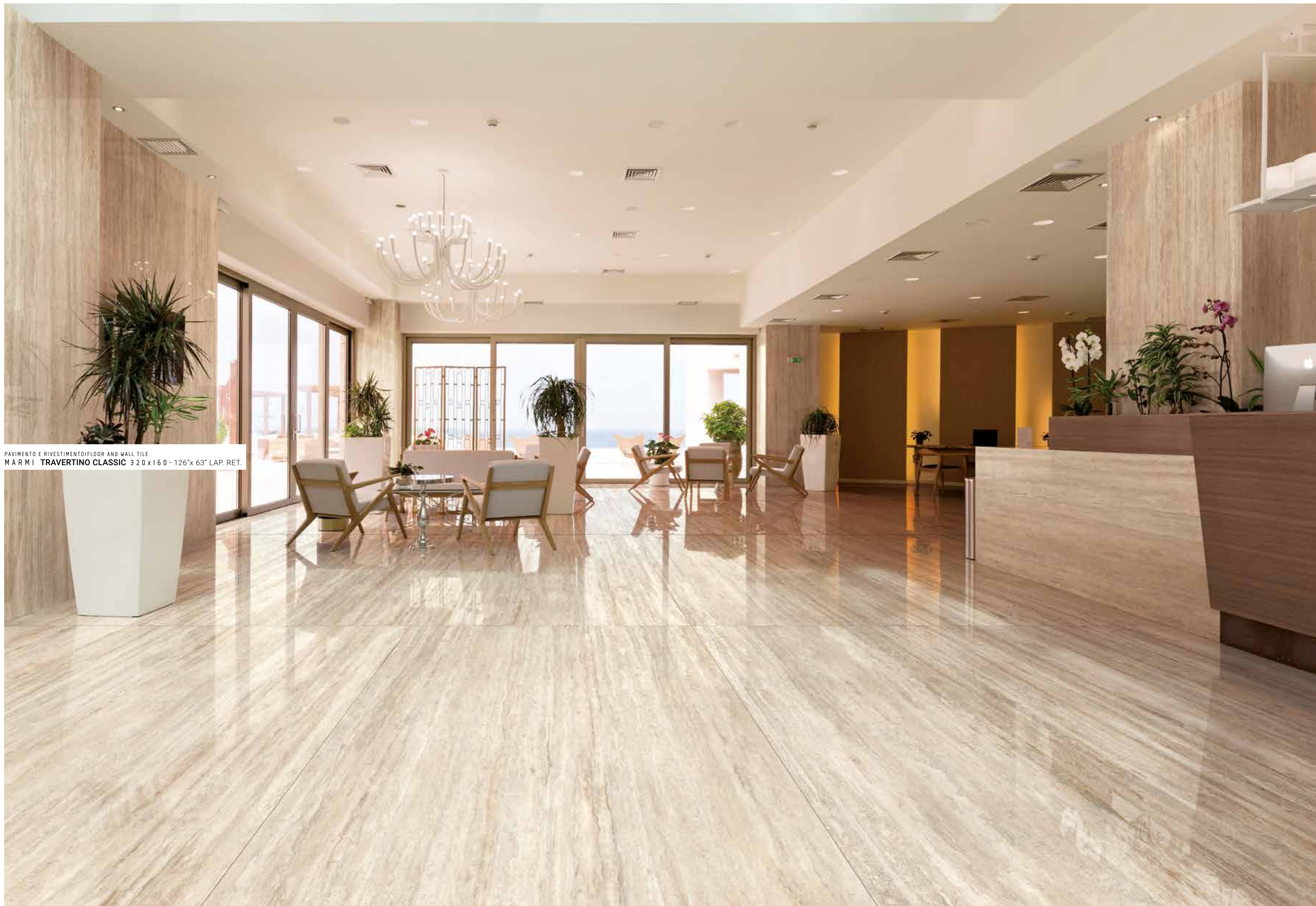

PAVIMENTO E RIVESTIMENTO/FLOOR AND WALL TILE
M A R M I T R A V E R T I N O C L A S S I C 3 2 0 x 1 6 0 - 1 2 6 " x 6 3 " L A P. R E T.

324x163
127"x64"
12 mm
1/2"
● Lap. Nat.

TAJ MAHAL

320x160
126"x63"
6 mm
1/4"
○ Lap. Ret.

324x163
127"x64"
12 mm
1/2"
■ Nat.
● Lap. Nat.

TRAVERTINO CLASSIC

320x160
126"x63"
6 mm
1/4"
□ Nat. Ret.
○ Lap. Ret.

Disponibile con ordine minimo di 1.200 m²

Available with minimum order of 1,200 m².
Quantité minimale par commande 1200 m².
Erhältlich bei einer Mindestbestellmenge von 1.200 m².
Disponibile bajo pedido mínimo de 1.200 m².
При минимальном заказе от 1200 м².
最少订购1,200平方米

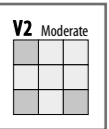

MARMI

TAJ MAHAL. TRAVERTINO CLASSIC.

LASTRE IN GRES PORCELLANATO PRESSATE A SECCO

Dry-pressed porcelain stoneware slabs. Dalles en grès cérame pressées à sec. Trockengepresste Platten aus Feinsteinzeug. Planchas en gres porcelánico prensadas en seco. Керамогранитные плиты сухого прессования. 干压陶瓷砖

Spessore. Thickness. Epaisseur. Stärke. Espesor. Толщина. 厚度 6mm - 10mm - 12mm*

UNI EN 14411-ISO 13006 appendice G gruppo Bla - UGL

Grande varietà nelle grafiche per un pavimento o rivestimento sempre vario a effetto "naturale" - The collection is available in a wide variety of graphics for varied floor or wall solutions with a "natural" effect. Grande variété des graphiques pour un carrelage de sol ou un revêtement mural toujours différent et un effet "naturel". - Große Vielfalt der Graphiken für einen ständig unterschiedlichen Boden- oder Wandbelag mit "natürlichem" Effekt. - Gran variedad en las gráficas para un pavimento o revestimiento siempre diferente de efecto "natural". - Предлагается большое разнообразие рисунков для укладки всегда меняющегося пола или облицовки с натуральным эффектом. * 多样的图案让地板和涂层具有不同的“天然”色彩。

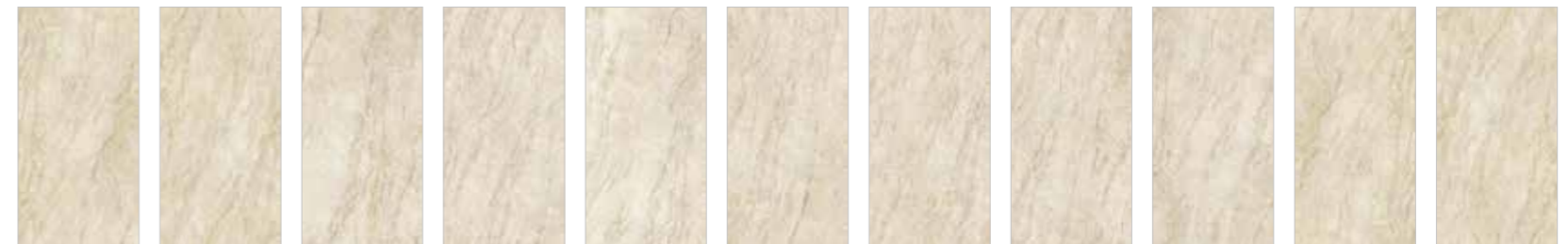

TAJ MAHAL



TRAVERTINO CLASSIC

		320x160 126"x63" 6 mm	160x160 63"x63" 6 mm	280x120 110"x48" 6 mm	240x120 96"x48" 6 mm	120x120 48"x48" 6 mm	160x80 63"x31 1/2" 6 mm	240x80 96"x31 1/2" 6 mm	80x80 31 1/2"x31 1/2" 6 mm	100x100 40"x40" 10 mm	120x60 48"x24" 10 mm	60x60 24"x24" 10 mm	324x163 127"x64" 12 mm*
Taj Mahal	○ Lap. Ret.	148001 M197	148041 M187	148021 M175	-	-	148081 M169	-	148101 M139	-	-	-	● Lap. Nat.
Travertino Classic	□ Nat. Ret.	138002 M173	138006 M161	-	138004 M153	138008 M141	138010 M141	-	138012 M125	-	138014 M109	-	■ Nat.
	○ Lap. Ret.	138001 M197	138005 M187	-	138003 M175	138007 M169	138009 M169	-	138011 M139	-	138013 M125	-	● Lap. Nat.

Il formato 324x163 in 12 mm è prodotto senza stuoia. La stuoia potrà essere aggiunta solo su specifica richiesta. Lo spessore delle lastre stuoiate è di 12,7 mm. The 324x163 size 12 mm thickness is produced without the fiber glass mesh. The fiber glass mesh will be supplied only on demand. The thickness of the mesh-mounted is 12,7 mm

*** Disponibile con ordine minimo di 1.200 m²**. Available with minimum order of 1,200 m². Quantité minimale par commande 1200 m². Erhältlich bei einer Mindestbestellmenge von 1.200 m². Disponible bajo pedido mínimo de 1.200 m². При минимальном заказе от 1200 м². 最少订购1,200平方米

- **Lappato e rettificato.** Lappato and rectified. Lappato et rectifié. Lappato und kalibriert. Lappato y rectificado. Лаппатированный ректифицированный. 亚光和抛光。
- **Naturale e rettificato.** Natural and rectified. Naturel et rectifié. Natur Oberfläche und kalibriert. Natural y rectificado. Натуральный ректифицированный. 天然和抛光。
- **Lappato con bordi naturali.** Lappato with non rectified edges. Lappato à bords naturels. Lappato mit natürlichen Kanten. Pulido con los bordes natural. Лаппатированная поверхность с матовой кромкой. 抛光带天然磨边。
- **Naturale.** Natural. Naturel. Natur natur. Natural. Натуральный. 天然。

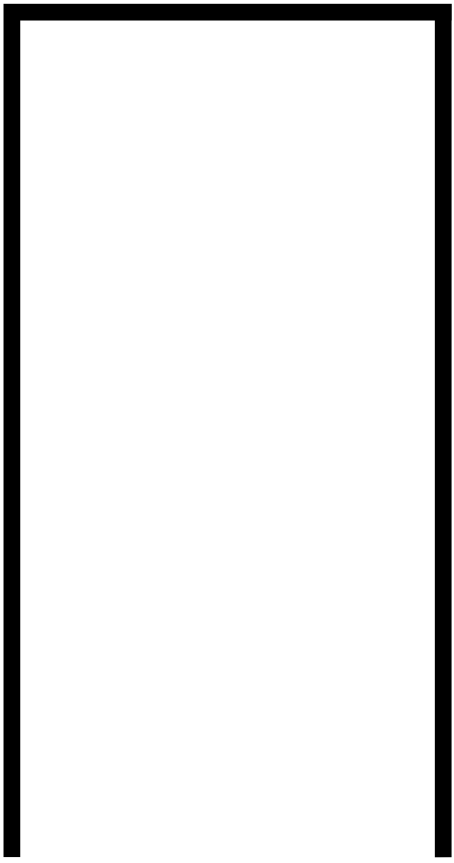

WHITE MACAUBA



WHITE MACAUBA
— M A R M I —



ABOUT WHITE MACAUBA

Affascinate per la sua luminosità ed eleganza, White Macauba rievoca la pietra naturale proveniente dalle cave del Brasile. La sua singolare caratteristica estetica e cromatica, data dallo sfondo di un bianco caldo striato da chiare venature grigio-marroni, lo rende particolarmente versatile ad ambienti di vario tipo, arredati in stile sia classico sia moderno.

Per completare la serie, AVA ha deciso di integrare la gamma con lastre dello spessore di 10 mm nel nuovo formato 180x80, in finitura lappata e naturale e di completare il formato 60x120, già presente in gamma nella finitura lappata, con la sua versione naturale.



MARMI / wall and floor: white macauba 320x160-126'x63' LAP. RET.

Charming for its luminosity and elegance, White Macauba evokes the natural stone from the Brazilian quarries. Its unique beauty and nuances, given its warm white background streaked with pale grey-brown veins, make it particularly versatile in a variety of settings, furnished in either classic or modern styles.

To complete the series, AVA decided to integrate the range with 10-mm thick slabs in the new 180x80 format, in either natural or lapped finishes, and add the natural finish to the 60x120 size, which is already available in the lapped finish.

Fascinant par sa luminosité et son élégance, le White Macauba évoque la pierre naturelle provenant des carrières du Brésil. Grâce à sa singulière caractéristique esthétique et chromatique, donnée par un fond d'un blanc chaud strié de veines gris-brun clair, il est particulièrement polyvalent pour différents types d'environnements, meublés en style classique ou moderne.

Pour compléter la série, AVA a décidé d'ajouter à la gamme des dalles de 10 mm d'épaisseur dans le nouveau format 180x80, en finition rodée et naturelle, et de compléter le format 60x120, déjà présent dans la gamme en finition rodée, avec sa version naturelle.

White Macauba fasziniert mit seiner strahlenden Eleganz und erinnert an die Natursteine aus den Steinbrüchen Brasiliens. Die außergewöhnlichen ästhetischen und farblichen Eigenschaften dieses Materials, ein cremeweißer Hintergrund, der von hellen, grau-braunen Äderungen durchzogen ist, sorgen für vielfältige Anwendungsmöglichkeiten sowohl in einem klassischen als auch modernen Ambiente.

Zur Vervollständigung der Serie hat AVA die 10 mm dicken Platten durch ein neues Format mit den Maßen 180x80 ergänzt, das sowohl in der Ausführung natur als auch anpoliert erhältlich ist. Außerdem ist das bereits in der Ausführung anpoliert vorhandene Format 60x120 jetzt auch in der Version natur verfügbar.

Fascinante por su luminosidad y elegancia, White Macauba evoca la piedra natural originaria de las canteras de Brasil. Su particular característica estética y cromática, debido al cálido fondo blanco estriado con claras vetas gris-marrón, lo vuelve especialmente versátil para ambientes de diferentes tipos, con decorado de estilo clásico o bien moderno.

Para completar la serie, AVA decidió integrar la gama con placas de 10 mm de espesor en su nuevo formato 180x80, con acabado lapado o natural, y completar el formato 60x120, ya en la gama con el acabado lapado, con la versión natural.

Покоряющая своим очарованием яркая и элегантная плитка White Macauba напоминает натуральный камень из бразильских каменоломен. Благодаря своим уникальным эстетическим и цветовым характеристикам - светлые серо-коричневые прожилки в виде полос на теплом белом фоне - эта плитка очень универсальна и подходит для отделки самых разных помещений как с классическим, так и с современным интерьером.

Чтобы дополнить серию, AVA решила ввести в ассортимент плиты толщиной 10 мм в новом формате 180x80 с лапатированной и натуральной отделкой поверхности, а к уже имеющемуся в коллекции лапатированному варианту в формате 60x120 добавить натуральный.

明亮和优雅的马卡巴 White Macauba 引人入胜，让人联想起巴西采石场的天然石材。独一无二的外观与色彩特征，暖色调的白色条纹基底加以清晰的灰棕色纹理，特别适用于各种类型的环境，无论古典风格，还是现代风格。为了使该系列完整，AVA 决定将该系列产品与 10mm 厚度，抛光表面和自然表面的新型 180x80 尺寸板材相结合，并在已有的抛光表面，60x120 规格尺寸的上增加了自然表面的板材。

WHITE MACAUBA

MARMI

LASTRE IN GRES PORCELLANATO PRESSATE A SECCO

Dry-pressed porcelain stoneware slabs. Dalles en grès cérame pressées à sec. Trockengepresste Platten aus Feinsteinzeug. Planchas en gres porcelánico prensadas en seco. Керамогранитные плиты сухого прессования. 干压陶瓷砖

UNI EN 14411-ISO 13006 appendice C gruppo BIa - UGL

SHADE SPECTRUM

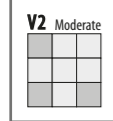

ANSI A 137.1: 2012
WET DYNAMIC COEFFICIENT OF FRICTION
DCOF ≥ 0.42

SOLO SUPERFICIE NATURALE
Only Natural Surface

Spessore.
Thickness.
Épaisseur.
Stärke.
Espesor.
Толщина.
厚度。



□ **Naturale e rettificato.**
Natural and rectified.
Naturel et rectifié.
Natur Oberfläche und kalibriert.
Natural y rectificado.
Натуральный ректифицированный.
天然和抛光。

● **Lappato con bordi naturali.**
Lappato with non rectified edges.
Lappato à bords naturels.
Lappato mit natürlichen Kanten.
Pulido con los bordes natural.
Лаппатированная поверхность с матовой кромкой.
抛光带天然磨边。

○ **Lappato e rettificato.**
Lappato and rectified.
Lappato et rectifié.
Lappato und kalibriert.
Lappato y rectificado.
Лаппатированный ректифицированный.
亚光和抛光。

● LAP.



324x163cm
127" x 64"

12mm*

○ LAP. RET.



320x160cm
126" x 63"



160x160cm
63" x 63"



160x80cm
63" x 31 1/2"



80x80cm
31 1/2" x 31 1/2"

6mm

MODULAR SYSTEM

○ LAP. RET.



240x120cm
96" x 48"



120x120cm
48" x 48"

6mm

MODULAR SYSTEM

□ NAT. RET. ○ LAP. RET.



180x80cm
71" x 31 1/2"

NEW SIZE

10mm

□ NAT. RET. ○ LAP. RET.



120x60cm
48" x 24"

NEW FINISH

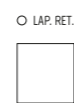

60x60cm
24" x 24"

10mm

MODULAR SYSTEM

* Disponibile con ordine minimo di 1.200 m²

Available with minimum order of 1.200 m². Quantité minimale par commande 1.200 m².
Erhältlich bei einer Mindestbestellmenge von 1.200 m². Disponible bajo pedido mínimo de 1.200 m². При минимальном заказе от 1.200 м². 最少订购1,200平方米。



WHITE
MACAUBA

100% DESIGN
AND PRODUCTION
OF ITALY



WHITE MACAUBA

MARMI

LASTRE IN GRES PORCELLANATO PRESSATE A SECCO

Dry-pressed porcelain stoneware slabs. Dalles en grès cérame pressées à sec. Trockengepresste Platten aus Feinsteinzeug. Planchas en gres porcelánico prensadas en seco. Керамогранитные плиты сухого прессования. 干压陶瓷砖

UNI EN 14411-ISO 13006 appendice C gruppo B1a - UGL

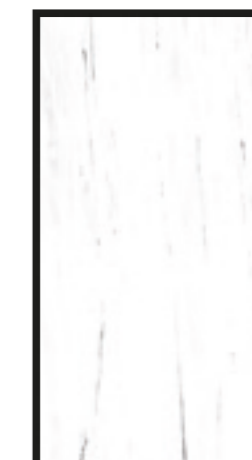

WHITE
MACAUBA

Grafiche Diverse.

Different patterns (based on size). Différents graphismes par format. Je nach Format verschiedene Grafifiken. Gráficas diferentes según formato. Кол. вариантов графики для каждого формата. 不同格式的图形.

7	7	14	28	56
324x163	320x160	160x160	160x80	80x80
11	22	14	18	36
240x120	120x120	180x80 NEW	120x60	60x60





MARMI / wall and floor: white macauba 180x80-71'x31 1/2' LAP. RET.

WHITE MACAUBA

MARMI

LASTRE IN GRES PORCELLANATO PRESSATE A SECCO

Dry-pressed porcelain stoneware slabs. Dalles en grès cérame pressées à sec. Trockengepresste Platten aus Feinsteinzeug.

Planchas en gres porcelánico prensadas en seco. Керамогранитные плиты сухого прессования. 干压陶瓷砖

UNI EN 14411-ISO 13006 appendice C gruppo Bla - UGL

Spessore. Thickness. Épaisseur. Stärke. Espesor. Толщина. 厚度 **6 mm - 10 mm - 12 mm***

Mxxx: Codice prezzo al mq. Sqm price code. Code prix au mq. Kode Preis pro Qm. Codigo de precio por metro cuadrado. цена за шт. 每平方米价格代码

	MODULAR SYSTEM				MODULAR SYSTEM				MODULAR SYSTEM	
	320x160 126"x63" 6 mm	160x160 63"x63" 6 mm	160x80 63"x31 1/2" 6 mm	80x80 31 1/2"x31 1/2" 6 mm	240x120 96"x48" 6 mm	120x120 48"x48" 6 mm	180x80 71"x31 1/2" 10 mm	120x60 48"x24" 10 mm	60x60 24"x24" 10 mm	324x163 127"x64" 12 mm*
□ Nat. Ret.	-	-	-	-	-	-	087614 M125	087133 M109	-	-
○ Lap. Ret.	087017 M197	087052 M187	087092 M169	087112 M139	087036 M175	087072 M169	087613 M143	087131 M125	087151 M113	-
● Lap. Nat.	-	-	-	-	-	-	-	-	-	087915 M247

Il formato 324x163 in 12 mm è prodotto senza stuoia. La stuoia potrà essere aggiunta solo su specifica richiesta. Lo spessore delle lastre stuoiate è di 12,7 mm. The 324x163 size 12 mm thickness is produced without the fiber glass mesh. The fiber glass mesh will be supplied only on demand. The thickness of the mesh-mounted is 12,7 mm.

* Disponibile con ordine minimo di 1.200 m². Available with minimum order of 1,200 m². Quantité minimale par commande 1200 m². Erhältlich bei einer Mindestbestellmenge von 1.200 m². Disponible bajo pedido mínimo de 1.200 m². При минимальном заказе от 1200 м². 最少订购1,200平方米

DECORI

Decors. Décors. Dekore. Decoraciones. Декоры. 饰

MOSAICO

30x30cm. 12"x12"

thickness 6mm

087168 ○ Lap. Ret.
M235

Decori disponibili su tutti i colori in gamma. Decors available for all the colors of this range. Décors disponibles dans toutes les couleurs de la gamme. Dekore in allen Farben der Kollektion verfügbar. Decorados disponibles en todos los colores. Декоры существуют во всех цветах коллекции. 装饰可以运用所有的颜色

○ Lappato e rettificato. Lappato and rectified. Lappato et rectifié. Lappato und kalibriert. Lappato y rectificado. Лаппатированный ректифицированный. 亚光和抛光。

○ Naturale e rettificato. Natural and rectified. Naturel et rectifié. Natur Oberfläche und kalibriert. Natural y rectificado. Натуральный ректифицированный. 天然和抛光。

● Lappato con bordi naturali. Lappato with non rectified edges. Lappato à bords naturels. Lappato mit natürlichen Kanten. Pulido con los bordes natural. Лаппатированная поверхность с матовой кромкой. 抛光带天然磨边。

** PEZZI SPECIALI

Trims . Pièces spéciales . Formstücke . Piezas especiales . Специальные элементы. 特别部件

Pxxx: Codice prezzo al pezzo. Code price per piece. Code prix à la pièce. Kode Preis pro Stück. Codigo de precio por unidades. цена за шт. 每片价格代码

COSTA RETTA:

Straight nose:

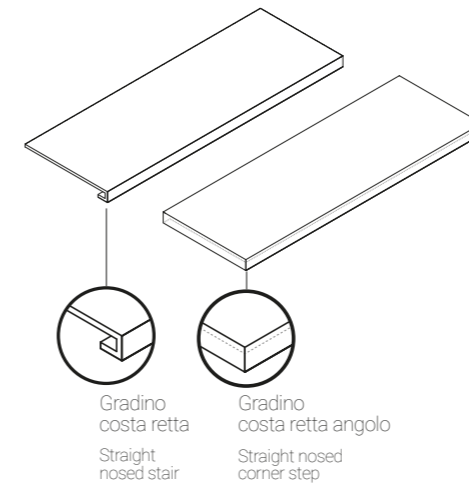

BORDO DRITTO:

Straight edge:

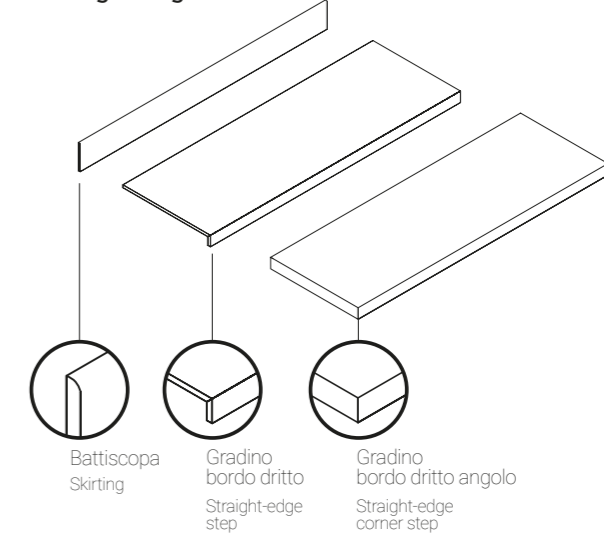

	Battiscopa 120x6,5 48"x2 1/2" 10mm	Battiscopa 80x8 31 1/2"x3" 6mm
○ Lap. Ret.	087223 P033	087225 P029
□ Nat. Ret.	087212 P029 NEW	-

	Gradino costa retta 160x33x3,2h 63"x13"x1 1/4" 6 mm	Gradino costa retta dx/sx 160x33x3,2h 63"x13"x1 1/4" 6 mm	Gradino costa retta 120x33x3,2h 48"x13"x1 1/4" 6 mm	Gradino costa retta dx/sx 120x33x3,2h 48"x13"x1 1/4" 6 mm	Gradino costa retta 80x33x3,2h 31 1/2"x13"x1 1/4" 6 mm	Gradino costa retta dx/sx 80x33x3,2h 31 1/2"x13"x1 1/4" 6 mm	Gradino costa retta 120x33x3,2h 48"x13"x1 1/4" 10 mm	Gradino costa retta dx/sx 120x33x3,2h 48"x13"x1 1/4" 10 mm
○ Lap. Ret.	087330 P323	087331 DX 087332 SX P339	087657 P265	087658 DX 087659 SX P283	087386 P175	087387 DX 087388 SX P215	087413 P215	087414 DX 087415 SX P243
□ Nat. Ret.	-	-	-	-	-	-	087552 P207 NEW	087553 DX 087554 SX P231 NEW

	Gradino bordo dritto 160x30x4h 63"x12"x1 1/4" 6 mm	Gradino bordo dritto dx/sx 160x30x4h 63"x12"x1 1/4" 6 mm	Gradino bordo dritto 120x30x4h 48"x12"x1 1/4" 6 mm	Gradino bordo dritto dx/sx 120x30x4h 48"x12"x1 1/4" 6 mm	Gradino bordo dritto 80x30x4h 31 1/2"x12"x1 1/4" 6 mm	Gradino bordo dritto dx/sx 80x30x4h 31 1/2"x12"x1 1/4" 6 mm	Gradino bordo dritto 120x30x4h 48"x12"x1 1/4" 10 mm	Gradino bordo dritto dx/sx 120x30x4h 48"x12"x1 1/4" 10 mm
○ Lap. Ret.	087436 P267	087437 DX 087438 SX P305	087479 P201	087480 DX 087481 SX P257	087512 P143	087624 DX 087514 SX P197	087648 P179	087649 DX 087650 SX P201
□ Nat. Ret.	-	-	-	-	-	-	087660 P173 NEW	087661 DX 087662 SX P201 NEW

** A disposizione solo su richiesta. Tempi di consegna: 30gg. Available upon request only. Delivery terms: 30 days. Disponible seulement sur requête. Délais de livraison: 30 jours. Verfügbar auf Anfrage. Lieferzeit: 30 Tage. Disponible sólo bajo pedido. Plazo de entrega: 30 días. Изготавливается только по специальной заявке. Срок поставки: 30 дней. 仅依订购。交货时间: 30日。



La Fabbrica S.p.A.
Via Emilia Ponente, 925
48014 Castel Bolognese (RA) Italy
Tel. +39 0546 - 659911
Fax +39 0546 - 656223
www.avaceramica.it
www.lafabbrica.it
info@lafabbrica.it

A company part of



Follow us

